

*VMB-HW



Installation, Operation, and Maintenance Instructions

WARNING TO INSTALLER, SERVICE PERSONNEL, AND OWNER



Altering the product, improper installation, or replacing parts with unauthorized parts voids all warranty or implied warranty and may result in adverse operational performance or possible hazardous conditions to service personnel and occupants. Company employees or contractors are not authorized to waive this warning.

- NOTES:
- *Read the entire installation instruction manual before starting the installation.*
 - *These instructions are intended as a general guide and do not supersede national, state, or local codes in any way.*
 - *These instructions must be left with the property owner.*

SAFETY CONSIDERATIONS

Improper installation, adjustment, alteration, service, maintenance, or use can cause explosion, fire, electrical shock, or other conditions which may cause personal injury or property damage. Consult a qualified licensed installer, service agency, or your distributor for information or assistance. The qualified licensed installer or service agency must use factory-authorized kits or accessories when modifying this product. Refer to the individual instructions packaged with kits or accessories when installing.

Follow all safety codes. Wear safety glasses and work gloves. Use quenching cloth for brazing operations. Have fire extinguisher available. Read these instructions thoroughly and follow all warnings or cautions attached to the unit. Consult local building codes and National Electrical Code (NEC) for special requirements.

Recognize safety information. This is the general safety-alert symbol . When you see this symbol on the unit and in instruction manuals, be alert to the potential for personal injury or damage to equipment. The lightning bolt symbol  signifies an electrical shock hazard.

 **WARNING:** *This WARNING signifies general hazards which could result in personal injury or death.*

 **WARNING:** *This WARNING signifies electrical shock hazards which could result in personal injury or death.*

 **CAUTION:** *CAUTION is used to identify unsafe practices which would result in product and property damage.*

NOTE: *NOTE is used to highlight suggestions which may result in enhanced installation, reliability, or operation.*

GENERAL

The manufacturer does not warrant equipment subjected to abuse. Metal chips, dust, drywall tape, paint overspray, etc. can void warranties and liability for equipment failure, personal injury, and property damage.

The manufacturer assumes no responsibility for equipment installed in violation of any code requirement.

-  **WARNINGS:**
- Always wear eye protection when working on equipment.
 - Before servicing unit, always turn off all power to unit. There may be more than one disconnect switch. Electrical shock can cause personal injury or death.
 - When fan coil is operating, some components are operating at high speeds. Personal injury can result from touching these items with any object.
 - All electrical and service access panels must be secured in their proper place before operating equipment.
 - Clear surrounding area of all tools, equipment and debris before operating unit.

 **CAUTION:** Unit must not be operated during building construction due to excessive airborne dust and debris. Also, the unit must never run under any circumstances without an air filter in place.

These instructions give information for installation of VMB-HW fan coil units only. For other related equipment, refer to the manufacturer's instructions.

Material in this shipment has been inspected at the factory and released to the transportation agency in good condition. When received, a visual inspection of all cartons should be made immediately. Any evidence of rough handling or apparent damage should be noted on the delivery receipt and the material inspected in the presence of the carrier's representative. If damage is found, a claim should be filed against the carrier immediately.

All models are designed for indoor installation only. The installation of this unit, field wiring, duct system, and other related equipment must conform to the requirements the National Electric Code, ANSI/NFPA No. 70 (latest edition) in the United States, as well as any state laws and local codes. Local authorities having jurisdiction should be consulted before installation is made. Such

applicable regulations take precedence over the general instructions contained in this manual.

Extreme caution must be taken that no internal damage will result if screws or holes are drilled into the cabinet.

INSTALLATION PRECAUTIONS



WARNING: Some units are very heavy. Use two or more people when moving and installing these units. Failure to do so could result in personal injury or death. Contact with metal edges and corners while applying excessive force can result in personal injury. Use gloves when handling equipment. Use caution during installation or while servicing equipment.



WARNING: Hot water can cause scalding. If hot water coil is connected to domestic potable water a hot water mixing valve can be applied to the system to temper domestic water draw.

Installation of this fan coil should be performed only by a licensed contractor to ensure proper installation and the safety of the installer. Observe the following precautions for typical installations:

- Always use proper tools and equipment.
- No wiring or other work should be attempted without first ensuring fan coil is completely disconnected from the power source and locked out. Always verify that a good permanent, uninterrupted ground connection exists prior to energizing any power sources.
- Always review the nameplate and wiring diagram on each unit for proper voltage and control configurations. This information is determined from the components and wiring of the unit and may vary from unit to unit.
- When soldering or brazing to the unit, it is recommended to have a fire extinguisher readily available. When soldering close to water valves or other components, heat shields or wet rags are required to prevent damage.
- When the fan coil unit is in operation components are rotating at high speeds.
- Units must be installed level or angled toward the drain nipple to ensure proper drainage and operation.
- Be sure that the drain pan is free from foreign material prior to start up.
- Check filter media installation to ensure that it is installed correctly. Use the directional arrows or other information on the filter to determine the proper flow direction.
- Ensure air distribution system does not exceed the external static rating of the unit.

NOTE: *The variable speed unit is compatible with damper duct systems when designed properly. Consult the damper system manufacturer for proper design.*

Insulation is installed in indoor equipment to provide a barrier between outside air conditions surrounding the unit and the varying conditions inside the unit. If the insulating barrier is damaged, the surrounding ambient air will affect the inside surface temperature of the cabinet. The temperature/ humidity difference between the inside and outside can cause condensation to form on the inside and outside of the cabinet which leads to sheet metal corrosion and subsequently component failure.

Damaged insulation must be repaired or replaced before the unit is placed back into operation. Insulation loses its insulation value when wet, damaged, separated, or torn.

NOISE These fan coil units are designed for quiet operation, however, all air conditioning equipment will transfer some amount of noise to the conditioned space. This should be taken into consideration when planning the location of the equipment.

FAN COIL UNIT

The installer must adhere strictly to all local and national code requirements pertaining to the installation of this equipment. All units are designed for indoor use only, and are agency listed for installation with zero clearance to combustible materials. This includes the unit cabinet, discharge plenum, and connecting ducts. These units are designed to be installed in either an upflow or horizontal position.

The VMB-HW Fan Coil can be installed for upflow and horizontal-left applications as factory shipped. Units can be installed for horizontal-right applications with field modifications.

Sufficient clearance must be provided at the front of the fan coil to allow access to electrical controls and removal of the motor/ blower assembly for servicing. This clearance distance should be approximately the same as the depth dimension of the fan coil unit.

IMPORTANT: When unit is installed over a finished ceiling and/or living area, building codes may require a field-supplied secondary condensate pan to be installed under the entire unit. Some localities may allow the alternative of running a separate secondary condensate line or applying a field mounted condensate overflow switch. Consult local codes for additional restrictions or precautions.



CAUTION: Extreme caution must be taken that no internal damage will result if screws or holes are drilled into the cabinet. Failure to follow this CAUTION could result in product or property damage and minor personal injury.

VERTICAL APPLICATION

Fan coil may be set on a platform and secured by screws or nails. Sufficient space for drain piping is required under the platform.

Sufficient clearance must be provided at the front of the fan coil to allow access to electrical controls and removal of the motor/ blower assembly for servicing. This clearance distance should be approximately the same as the depth dimension of the fan coil unit.

- NOTE:**
- *A field-fabricated secondary drain pan, with a drain pipe routed to the outside of the building, may be required in installations over a finished living space or in any area that may be damaged by water overflow from the main drain pan. In some localities local codes may require a secondary drain pan for any horizontal installation.*
 - *If a condensate overflow shut off switch, that is designed to be installed in the drain line, is used in place of a secondary drain line then place it in the primary drain line between the fan coil and the P-trap.*

HORIZONTAL APPLICATION

The fan coil units are factory assembled for horizontal left side down application without any modification required. To convert to horizontal right side down, remove horizontal drain pan and A-coil assembly, flip horizontal drain pan over to right side and reinstall horizontal drain pan and A-coil into cabinet. Secure forward edge of horizontal drain pan with angle bracket. The unit should be leveled in such a way that there is slope toward the condensate drain nipple to assure positive drainage.



CAUTION: It is highly recommended that an auxiliary drain pan be located beneath the fan coil to prevent damage which may result from an overflow of the condensate pan.

MOUNTING

It is important to ensure that the fan coils are securely mounted and the structure is sufficient to support the weight of the equipment. All anchors for mounting the equipment must be placed and sized to ensure a safe and durable installation.

FAN COIL CONFIGURATION

The VMB-HW fan coil units are supplied with a chilled water coil and hot water coil.



WARNING: Hot water can cause scalding. If hot water coil is connected to domestic potable water a hot water mixing valve can be applied to the system to temper domestic water draw.

AIR DISTRIBUTION DUCTS

All duct work must be installed in accordance with National Fire Protection Association Codes 90A and 90B. Supply and return duct system must be adequately sized to meet the system’s air requirements and static pressure capabilities. Ducts should be adequately insulated to prevent condensation during the cooling cycle and to minimize heat loss during the heating cycle. The ducts should be insulated with a minimum of 1-inch insulation with a vapor barrier in conditioned areas or 2-inches minimum in unconditioned areas. All return air must be filtered to prevent dirt buildup on the coil surface. If there is no ducted return, applicable installation codes may limit the unit to installation only in a single story residence. In many cases it is acceptable to use ducting of the same size as the fan coil connections. However, unique arrangements or long duct runs must be confirmed by a local professional. The manufacturer will not be responsible for misapplied equipment.

DUCTWORK ACOUSTICAL TREATMENT

Metal duct systems that do not have a 90 degree elbow and 10 ft. of main duct to first branch takeoff may require internal acoustical insulation lining. As an alternative, fibrous ductwork may be used if constructed and installed in accordance with the latest edition of SMACNA construction standard on fibrous glass ducts. Both acoustical lining and fibrous ductwork shall comply with National Fire Protection Association Standards 90A or 90B as tested by UL Standard 181 for Class 1 air ducts.

ELECTRICAL



WARNINGS: Electric Shock Hazard

- Disconnect all power supplies before servicing; lock out/tag out to prevent accidental electrical shock. Note: there may be multiple power sources.
- Use copper conductors only.
- Install all parts and panels before operating.
- Failure to follow these warnings can result in injury or death.

All wiring must comply with local and national code requirements. Units are provided with wiring diagrams and nameplate data to provide information required for necessary field wiring.

These units are provided with a Class 2 transformer for 24-volt control circuits. Should any add-on equipment also have a Class 2 transformer furnished, care must be taken to prevent interconnecting outputs of the two transformers by using a thermostat with isolating contacts.



WARNING: Units with ECM motors have line voltage power applied at all times. Make sure power is disconnected before servicing.

NOTE: *Before proceeding with electrical connections, make certain that supply voltage, frequency, and phase are as specified on unit rating plate. Be sure that electrical service provided by the utility is sufficient to handle the additional load imposed by this equipment. See unit wiring label for proper field high and low voltage wiring. Make all electrical connections in accordance with NEC and any local codes or ordinances that may apply.*



CAUTION: If a disconnect switch is to be mounted on the unit, select a location where drill or fastener will not contact electrical or refrigerant components. Electrical shock can cause personal injury or death.

LINE-VOLTAGE CONNECTIONS

Connect designated supply voltage from field disconnect to unit terminal block.

Connect ground wire to unit ground lug.

Check all factory wiring per unit wiring diagram and inspect factory wiring connections to be sure none were loosened in transit or installation.



WARNING: The cabinet must have an uninterrupted or unbroken ground according to NEC, ANSI/NFPA 70 and local codes to minimize personal injury if an electrical fault should occur. The ground may consist of electrical wire or metal conduit when installed in accordance with existing electrical codes. (See Ground/Conduit Note below.) Failure to follow this warning could result in an electrical shock, fire, or death.

24V CONTROL SYSTEM CONNECTIONS TO UNIT CIRCUIT BOARD

Refer to unit wiring diagram for recommended wiring procedures. Use No. 18 AWG color-coded, insulated (35 degrees C minimum) wires to make low-voltage connections between thermostat and unit. If thermostat is located more than 100 ft. from unit (as measured along the low-voltage wires), use No. 16 AWG color-coded, insulated (35 degrees C minimum) wires.

Connect low-voltage thermostat leads and low-voltage outdoor unit leads to the fan coil circuit board as shown on unit wiring diagram. (See Figure 1.)



CAUTION: Do not use power stealing thermostats. The thermostat will cause the motor to function improperly. A high grade digital thermostat is recommended. Failure to do so could result in damage to components and will void all warranties.

These fan coils are provided with a Class 2 transformer for 24volt control circuits. Should any add-on equipment also have a Class 2 transformer furnished, care must be taken to prevent interconnecting outputs of the two transformers by using a thermostat with isolating contacts.



CAUTION: Any devices such as fan switches or thermostats that have been furnished by the factory for field installation must be wired in strict accordance with the wiring diagram that is supplied with the unit. Failure to do so could result in damage to components and will void all warranties.

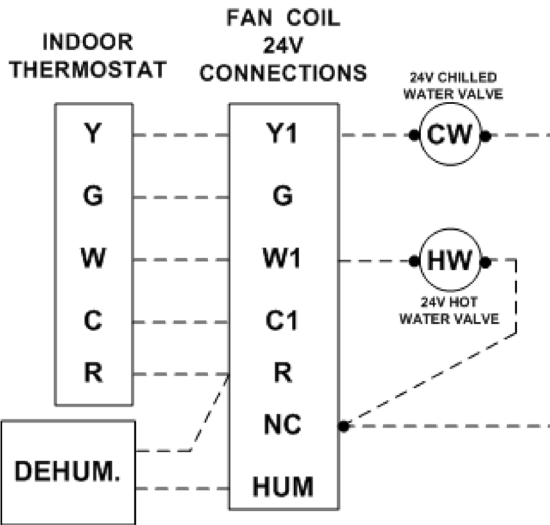

FIGURE 1. - Low Voltage Wiring Connections

PIPING

PIPING PRECAUTIONS

1. Flush all field piping prior to connection to remove all debris.
2. Use wet cotton rags to cool valve bodies when soldering.
3. Open all valves (mid-way for hand valves, manually open on motorized valves) prior to soldering.
4. When soldering to bronze or brass, heat the piping while in the socket/cup and begin introducing the solder when the flux boils rapidly. Avoid direct flame into the solder joint.
5. Heat can only be applied to the cup of the valve body for a minimal time before damage occurs (even with the use of wet rags).
6. Avoid rapid quenching of solder joints as this will produce joints of inferior quality
7. Provisions must be made for expansion and contraction of piping systems. All horizontal and vertical risers, including runouts, must be able to withstand significant movement with temperature changes. Failure to do so will result in damage and failure of piping, fittings and valves throughout the building.
8. Never insulate the heads or motorized portion of control valves. Damage can occur in the form of excessive heat build up and interference to the operation and moving parts will result.
9. All piping made in the field should be installed with consideration of additional space for any electrical routing that may be required.
10. Connect all piping per accepted industry standards and observe all regulations governing installation of piping systems.



CAUTION:

Hydronic systems are not designed to hold pressurized air and should only be tested with water. Pressurizing system with air could damage equipment.

11. When all connections are complete, pressure test system. Repair any solder joint leaks and gently tighten any leaking valve packing nuts and piping accessories, as required.

NOTE: *Coil freeze protection is recommended for applications where the fan coil is located in ambient air locations (attics, crawl spaces, etc.) or within structures that may be unoccupied during freezing conditions. Consult the factory for additional information.*



CAUTION: An expansion tank may be required if a back-flow preventer is installed in the system. Failure to follow this CAUTION could result in product and property damage.

PIPING INSTALLATION

These units employ a hydronic coil designed for use with either hot or chilled water.

- All piping must be adequately sized to meet the design water flow requirements as specified for the specific installation. Piping must be installed in accordance with all applicable codes.
- The piping connections on the equipment are not necessarily indicative of the proper supply and return line sizes. To minimize restrictions, piping design should be kept as simple as possible.



- CAUTIONS:**
- When connecting piping to fan coil units, do not bend or reposition the coil header tubing for alignment purposes. This could cause a tubing fracture resulting in a water leak when pressure is applied to the system.
 - Prior to connecting to the fan coil all external piping must be purged of debris.
 - All chilled water piping must be insulated to prevent property damage from condensation and it is also recommended that all piping be insulated to prevent freezing when piping is run in an unconditioned space.

PIPING INSULATION

Installing Contractor - After the system has been proven leak free, all lines and valve control packages must be insulated to prevent condensate drippage or insulated, as specified on the building plans.

NOTE: *Many valve packages will not physically allow all components to fit over an auxiliary drain pan. It is the installers responsibility to insulate all piping to ensure adequate condensation prevention.*

CHILLED WATER COIL PIPING

Chilled water coil connections are 3/4 inch nominal (7/8" OD) copper on the 8/12VMB-HW and 1 inch nominal (1-1/8" OD) copper on the 16/20VMB-HW. All piping should be copper and should not exceed 200 feet of total piping. It is recommended that 3/4" nominal (7/8" OD) piping should be used on the 8/12VMB-HW units and 1" nominal (1-1/8" OD) on the 16/20VMB-HW unit to prevent excessive head pressure losses. (Consult the factory for other piping applications.)

HOT WATER COIL PIPING

Hot water coil connections are 3/4 inch nominal (7/8" OD) copper except the 20VMB-HW is 1 inch nominal (1-1/8" OD). The hot water supply to the fan coil will be on the right when facing the fan coil upright and from the front. All piping between the water heater and fan coil unit should be copper and should not exceed 200 feet of total piping. It is recommended that 3/4" nominal (7/8" OD) piping should be used on 8 thru 16VMB-HW units and 1" nominal (1-1/8" OD) on 20VMB-HW unit to prevent excessive head pressure losses. (Consult the factory for other piping applications.) It is also recommended that all piping be adequately insulated to prevent freezing when piping is run in an unconditioned space. Failure to follow this could result in product and property damage due to frozen water line breakage.

NOTE: *Hot water coil freeze protection is available for applications where the fan coil is located in ambient air locations (attics, crawl spaces, etc.) or within structures that may be unoccupied during freezing conditions. Consult the factory for additional information.*

NOTE: *A water heater is designed to produce hot water. Hot water represents a serious safety hazard due to potential scalding. The temperature of water normally required to provide space heating (135 to 140 degrees) may be hotter than certain codes allow for domestic hot water. An "anti-scald valve" can be installed in the hot water piping that would allow the domestic water to be supplied at a lower temperature than the space heating water. These can be obtained locally and should be installed according to the manufacturer's installation instructions.*

CONDENSATE DRAIN

Units are equipped with primary and secondary 3/4 in. MPT drain connections. For proper condensate line installation. (See Figure 2.) To prevent property damage and achieve optimum drainage performance, both primary and secondary drain lines should be installed and include properly-sized condensate traps. (See Figure 2 and 4.) Since the drain pan is located on the suction side of the blower, a negative pressure exists at the drain pan and a minimum trap of 1-1/2 inches must be provided in the drain line to assure proper drainage. On units with plastic pans the drain connections must be made hand tight only.



CAUTION: Shallow running traps are inadequate and DO NOT allow proper condensate drainage. (See Figure 3.) Failure to follow this CAUTION could result in product and property damage.

NOTE: *If a Condensate Overflow Shut-off Switch, that is designed to be installed in the drain line, is used in place of a secondary drain line, then the cut-off switch should be located in the primary drain line between the fan coil unit and the P-trap.*

NOTE: *When connecting condensate drain lines avoid blocking filter access panel. Prime both primary and secondary condensate traps after connecting to drain pan.*

NOTE: *If unit is located in or above a living space where damage may result from condensate overflow, a field-supplied external condensate pan should be installed underneath the entire unit, and a secondary condensate line (with appropriate trap) should be run from the unit into the pan. Any condensate in this external condensate pan should be drained to a noticeable place. As an alternative to using an external condensate pan, some localities may allow the use of a separate 3/4 in. condensate line (with appropriate trap) to a place where the condensate will be noticeable. The owner of the structure must be informed that when condensate flows from the secondary drain or external condensate pan, the unit requires servicing, or water damage will occur.*

Install traps in the condensate lines as close to the coil as possible. Make sure that the outlet of each trap is below its connection to the condensate pan to prevent condensate from overflowing the drain pan. Prime all traps, test for leaks, and insulate traps if located above a living area.

Condensate drain lines should be pitched downward at a minimum of 1 in. for every 10 ft. of length. Consult local codes for additional restrictions or precautions.

AUXILIARY CONDENSATE SWITCH

Auxiliary condensate switch may be installed in lieu on auxiliary drain line as permitted by local code.

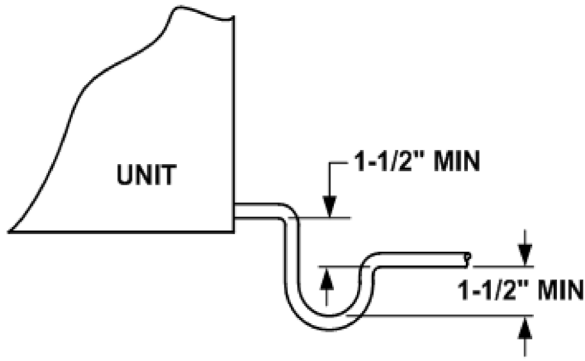

FIGURE 2. - Recommended Condensate Trap



DO NOT USE SHALLOW RUNNING TRAPS!

FIGURE 3. - Insufficient Condensate Trap

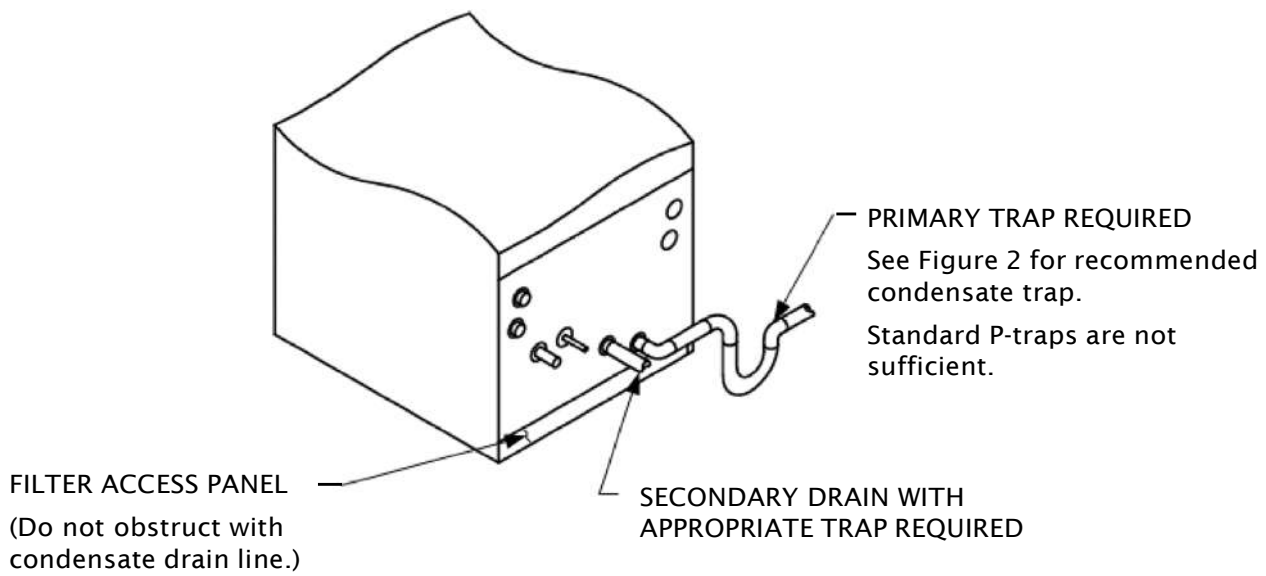

FIGURE 4. - Condensate Trap and Unit

PRE-STARTUP CHECKS

WARNINGS:

- Electrically ground fan coil. Connect ground wire to ground terminal marked “GND”. Failure to do so can result in injury or death.
- Do not touch any rotating component with any object. Damage to the equipment and personal injury can occur.

CAUTION:

Any device such as a fan switch or thermostat that has been furnished by the factory for field installation must be wired in strict accordance with the wiring diagram that is supplied with the unit. Failure to do so could result in damage to components and will void all warranties.

Before start-up, all of the components should be given a thorough check. Optimal operation of this equipment requires cleanliness. Often after installation of this equipment additional construction activities occur. Care must be taken to protect the equipment from debris during these construction phases.

Prior to starting the unit:

1. Ensure supply voltage matches nameplate data.
2. Ensure unit is properly grounded.
3. With power off, check blower wheel set-screws for tightness and ensure blower wheels rotate freely and quietly. Ensure fan coil is properly and securely installed.

NOTE: *Remove the motor blower shipping brace on the 20VMB-HW blower assembly. Failure to do so will cause damage to the unit.*

4. Ensure unit is sloped toward drain line.
5. Ensure unit will be accessible for servicing.
6. Ensure condensate line is properly sized, run, trapped, pitched and tested.
7. Ensure all cabinet openings and wiring connections have been sealed.
8. Ensure a clean filter is in place and of adequate size.
9. Ensure all access panels are in place and secured.
10. Check that the water coil, valves and piping have been leak checked and insulated as required.
11. Ensure that all air has been vented from the water coil.

NOTE: *It may require purging several gallons of water so have a means of discarding the water.*



CAUTION: The fan coil unit should not be energized until the water coil and all water lines have been purged of air. Failure to follow this CAUTION could result in product and property damage.

MAINTAINING LOW AIR LEAKAGE RATE

During installation, ensure that all grommets and gaskets remain intact on all surfaces as shipped with the unit. Any knockouts, penetrations, and holes that were exposed must be sealed to prevent air leakage. All access panels and covers must be flush with each other and the cabinet. With these requirements satisfied, the unit will maintain and achieve less than 2% air flow leakage when tested in accordance with ASHRAE Standard 193.

APPLICATION AND BLOWER SPEED SELECTION

Select taps are used by the installer to properly configure the system. The ECM motor uses the selected taps to modify its operation to a pre-programmed table of airflows. (See Table 1.) Airflows are based on the system size or mode of operation and those airflows are modified in response to other inputs such as the need for dehumidification. The unit will deliver a constant airflow, based on the table of airflows and select taps, with a system static pressure up to 0.5 in H₂O.

NOTE: *The variable speed unit is compatible with damper duct systems when designed properly. Consult the damper system manufacturer for proper design.*

NOTE: *The unit may appear to 'pulse' with system static pressures greater than 0.5 in H₂O.*

Model	Operating Mode	Thermostat Terminals "X" Energized Terminal				Control Board Select Taps							
		Y1	HUM	G	W1	COOL (CFM)				HEAT (CFM)			
						A	B	C	D	A	B	C	D
8VMB-HW	Cooling	X				800	720	640	560				
	Cool & Dehumidify	X	X			640	575	510	450				
	Continuous Blower			X		400	360	320	280				
	Heating				X					800	700	600	500
12VMB-HW	Cooling	X				1200	1050	950	850				
	Cool & Dehumidify	X	X			960	840	760	680				
	Continuous Blower			X		600	525	475	425				
	Heating				X					1200	1050	900	750
16VMB-HW	Cooling	X				1600	1420	1270	1120				
	Cool & Dehumidify	X	X			1280	1135	1015	900				
	Continuous Blower			X		800	710	635	560				
	Heating				X					1600	1400	1200	1000
20VMB-HW	Cooling	X				1825	1700	1600	1400				
	Cool & Dehumidify	X	X			1460	1360	1280	1120				
	Continuous Blower			X		1000	900	800	700				
	Heating				X					1825	1700	1500	1250

Airflow shown are at standard air conditions, dry coil at 120volts.

The cooling and heating speed taps are factory set on "A".

The delay profile is factory set on "Arid" setting.

The adjust profile is factory set on Normal.

Adjust profile (+) will increase airflow by 10%, while tap (-) will decrease airflow by 10%.(Except 20VMB-HW)

COOLING SELECT TAP Select system airflow for cooling output. (See Figure 5.)
Refer to Table 1 to select the proper airflow and Select Tap for the chilled water coil installed. Proper selection should be derived from BTUH output of the coil from the unit specification sheet. The typical selection would be 350 to 400 CFM per ton.

HEATING SELECT TAP Select system airflow for heat output. (See Figure 5.)
Refer to Table 1 to select the proper airflow and Select Tap for the hot water coil installed. Proper selection should be derived from BTUH output of the coil from the unit specification sheet. The typical selection would be 350 to 400 CFM per ton.

ADJUST SELECT TAP Select system CFM airflow requirement. (See Figure 5.)
Adjust select options are provided to adjust airflow supplied to meet individual installation conditions such as noise, comfort and humidity removal. To provide airflow at rates described in Table 1, the Adjust Tap is factory set at nominal (NORM). The adjust selections will regulate airflow supplied for all operational modes. The (+) tap provides 10 percent airflow over nominal airflow selected and the (-) tap provides 10 percent airflow below nominal airflow selected.

DELAY SELECT TAP Select desired delay profiles. (See figure 5.)
Four operation delay profiles are provided to customize and enhance system operation.

NOTE: *The delay profiles are active only in the cooling modes.*

Selection Options:

A - Arid Climates - the motor is programmed with a minimum ramp time to achieve full cooling capacity within a short time period. The off cycle delay is programmed with a reduced airflow over an extended time period.
B - Mild Humid Climates - the motor is programmed with ramp time and speed to achieve dehumidification on cooling start-up, thus allowing more moisture to collect and drain from the coil. The off cycle delay is programmed with a reduced airflow and short time period to enhance system efficiency and minimize re-evaporation of condensate.

C - Humid Climates - the motor is programmed with extended ramp time and reduced speed to achieve maximum dehumidification on cooling start-up, thus allowing more moisture to collect and drain from the coil. There is no off cycle delay programmed to eliminate re-evaporation of condensate.

D - No Delays - the motor is programmed with no delays to represent normal operation of a standard air handler.

HEAT DELAY The motor is factory programmed with a pre-purge time to permit the circulator to circulate hot water to the fan coil before the blower operates at a reduced CFM. The off cycle delay is programmed with a reduced airflow over a short time period to post purge the heat out of the water coil and duct system.

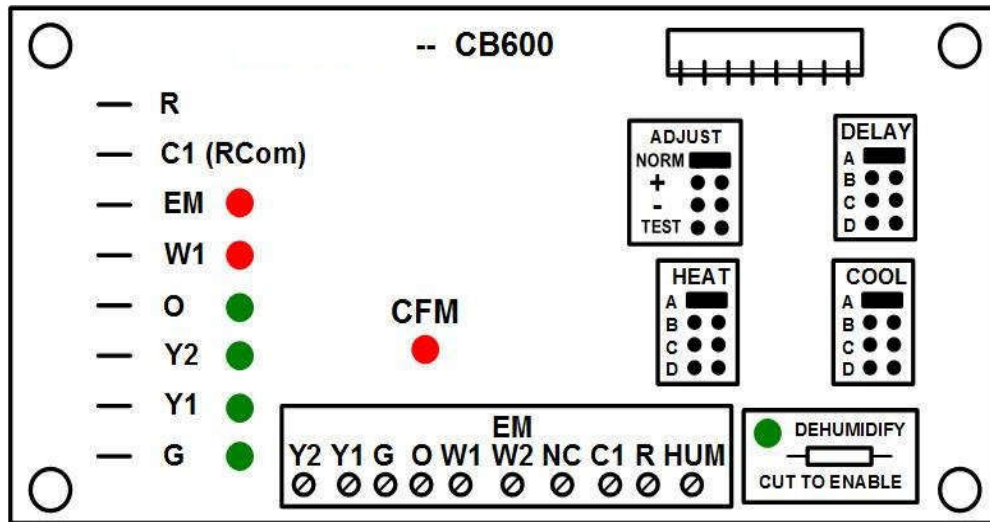

FIGURE 5. - Select Control Board

NOTE: The unit does NOT read changes in COOL, HEAT, and DELAY taps while it is running. Disconnect power for 1 minute before changing taps, then restart for the new settings to take affect.

DEHUMIDIFY CAPABILITY WITH STANDARD DEHUMIDISTAT CONNECTION

Latent capacities for systems using the VMB-HW Fan Coil are better than average systems. If increased latent capacity is an application requirement, the field wiring terminal block provides connection terminals for use with a standard dehumidistat. The fan coil will detect the dehumidistat contacts opening on increased humidity and reduce its airflow to approximately 80 percent of nominal cooling airflow. This reduction will increase the system latent capacity until the humidity falls to a level, which causes the humidistat to close its contacts. When the contacts close, the airflow will return to 100 percent of the selected cooling airflow. To activate this mode, cut the resistor located on the lower right hand corner of the selection control board and wire in a standard dehumidistat. (Refer to figure 6.)

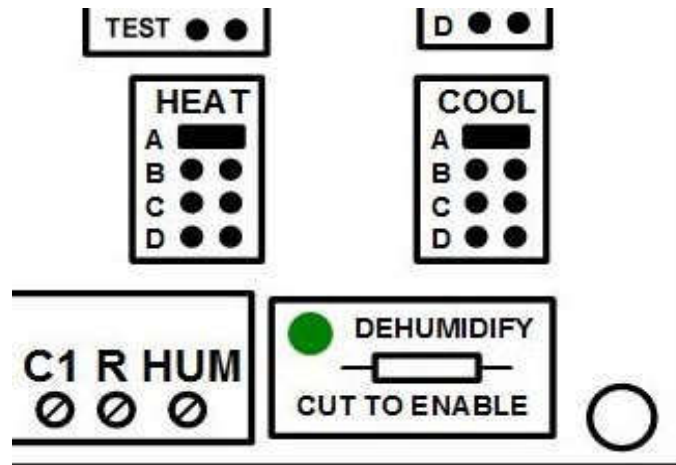

FIGURE 6. - Dehumidify Resistor on Select Control Board

SEQUENCE OF OPERATION

CONTINUOUS FAN	Thermostat closes circuit R to G. The blower runs continuously at a reduced airflow.
COOLING MODE	If indoor temperature is above thermostat set point and humidity is below humidity set point if dehumidistat is installed, thermostat closes circuits R to G and R to Y1. The fan coil delivers cooling airflow.
COOLING MODE – DEHUMIDIFICATION	If indoor temperature is above thermostat set point and humidity is above humidity set point if dehumidistat is installed, thermostat closes circuit R to G and R to Y1 and dehumidistat opens R to HUM. The fan coil delivers airflow, which is approximately 80 percent of the nominal cooling airflow to increase latent capacity of the system.
HOT WATER HEATING MODE	If indoor temperature is below thermostat set point, thermostat closes circuit R to W1. The fan coil delivers the selected hot water heating airflow.

TROUBLESHOOTING ECM MOTOR AND CONTROLS



CAUTION:

High voltage is always present at the motor. Disconnect power to the unit before removing or replacing connectors or servicing motor. Wait at least 5 minutes after disconnecting power before opening motor. Failure to follow this CAUTION could result in personal injury or product and property damage.

The ECM motor contains two parts: the control module and motor winding section. **Do not assume the motor or module is defective if it will not start.** Go through the steps described below before replacing control module, Select Control Board or entire motor. The control module is available as a replacement part.

IF MOTOR TURNS SLOWLY:

1. Replace panel and check air filter. Motor may appear to run slowly if access panel or air filter is removed.
2. It is normal operation to run noticeably slower if G terminal is energized without a call for heat or cooling.

IF MOTOR DOES NOT RUN:

1. Check for 24VAC at terminal R and C1. If no voltage is present, check the transformer.
2. Check all plugs and receptacles for any deformation, which could cause loose connections. Be sure plugs are fully seated.
3. Verify that supply voltage is present at the motor.

CHECK CONTROL SIGNALS:

Verify low voltage control signals to motor. The motor receives its control signals through the 16-pin wiring harness. The combination of pins energized will determine the motor speed. See table 2 for pin number on 16-pin plug which should have voltage when Select Control Board screw terminals have 24VAC.

TROUBLESHOOTING

THERMOSTAT

1. Remove all thermostat wires from Select Control board,
2. Jumper screw terminals on the select control board one at a time: R-G, R-Y1, and R-W1. If motor runs in all cases, thermostat is miswired, configured incorrectly, or defective. If motor runs in some cases, but not others, continue to check wiring harness and circuit board.

16-Pin Motor Wiring Harness to 16-Pin Connector on Select Board			
Pin # on 16-Pin Connector	Description		Signal on pin with Screw Terminal Jumpered to R *
1	Common		
2	W/W1	Heating Signal	24VAC **
3	Common		
4	Delay Adjust		
5	Cool Fan Adjust		
6	Y1	Cooling Signal	(-) 12VDC **
7	CFM Adjust		
8	Not Used		
9	"O" (HP/Cool)		
10	Dehumidify		0V (24VAC on no ca)
11	Heat Fan Adjust		
12	24V AC		24VAC continuous
13	W2 / EM	Not used	
14	Y / Y2	Not Used	
15	G	Fan Signal	24VAC **
16	Not Used		

* Check voltages with 16-Pin Plug disconnected from the motor.

** These signals will start the motor.

Dehumidify - 24 VAC is present with a call for no dehumidication.

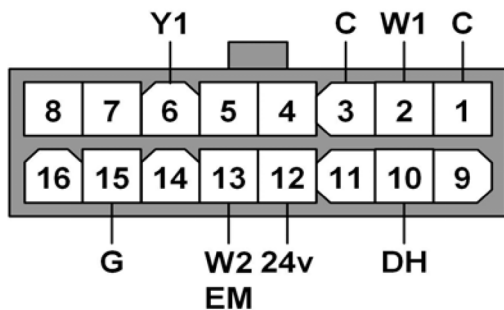
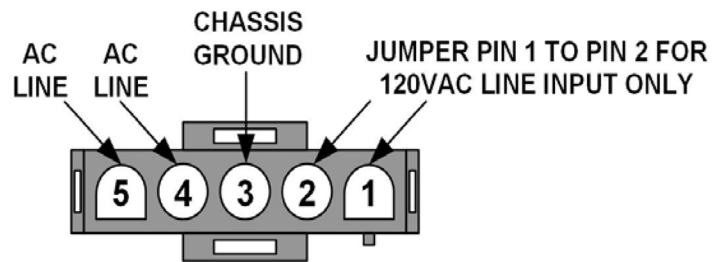

FIGURE 7. - 16 Pin Signal Connector



⚡ FIGURE 8. - 5 Pin Power Connector
WARNING: Applying 240VAC line input with Pin 1 and Pin 2 jumper in place will permanently damage unit.

WIRING HARNESS

1. Shut off power to unit. Wait 5 minutes.
2. Remove 5-pin connector from motor.
3. Remove 16-pin connector from motor.
4. Replace 5-pin plug and turn power on.
5. Check for correct voltages on 16-pin connector with screw terminals jumpered. (See table for values.)

If signals check correctly and motor does not run, inspect wiring harness for loose pins or damaged plastic connectors that could cause poor connections. If connections are good, either motor control module or motor is defective. If proper signals are not present, check Select Control Board using procedure below:

16-pin Plug on Select Control Board

1. Unplug wiring harness from board.
2. Check for appropriate voltage on connector pins with Select Control Board terminals jumpered. See table 2 for values and example below.

If proper signals are not present, replace the Select Control Board. If signals are present at the board and not the other end of the wiring harness, the wiring harness is defective.

TROUBLE SHOOTING EXAMPLE:

Motor is not running on a call for Cooling.

1. After performing checks in Thermostat section, follow steps 1 thru 5 in the Wiring Harness section. Then proceed with the example.
2. With all thermostat wires removed from the Select Control board, place a jumper wire between R and Y1 low voltage terminals on the Select Control board.
3. Check table 2 for pin number on the 16-pin connector associated with the Y signal. The correct pin is #6. The far right column shows that (-) 12VDC should be present between pin #6 and pin #1 (common) on the 16-pin connector.
4. Set meter to read DC voltage. Place meter between pins #1 and #6 and check for (-) 12VDC (common side of meter on pin #1.) If signal is present, the problem is the module or motor. If signal is not present, then problem is either wiring harness or Select Board.

These steps can be repeated for the other modes of operation.

TO CHECK SELECT CONTROL BOARD:

1. Leave jumper wire in place between R and Y1.
2. Remove 16-pin wiring harness from the Select Control Board.
3. Check table 2 for pin number on the 16-pin connector associated with the Y signal. The correct pin is #6. The far right column shows that (-) 12VDC should be present between pin #6 and pin #1 (common) on the 16-pin socket connector.
4. Place meter between pins # 6 and #1 on the socket connector and check for (-) 12VDC.
5. If voltage is present, the wiring harness is bad. If not, the Select control Board is bad.

To check Select Control Board:

**VERIFY MOTOR
WINDING SECTION:**

Before proceeding with module replacement, check the following to ensure motor winding section is functional. With control module removed and unplugged from the winding section:

1. The resistance between any 2 motor leads should be similar.
2. The resistance between any motor lead and unpainted motor end plate should be greater than 100K ohms.
3. If motor winding section fails one of these test, it is defective and must be replaced.

MAINTENANCE



WARNING: Disconnect all power to unit before servicing field wires or removing control package. The disconnect (when used) does not disconnect power to the line side of the disconnect, but does allow safe service to all other parts of the unit. If the unit does not have a disconnect, disregard the foregoing. Instead, make sure that a disconnecting means is within sight from, and is readily accessible from, the unit. Disconnect all power to the unit before performing any maintenance or service on it. Failure to follow this WARNING can cause electrical shock, fire, personal injury or death.

The minimum maintenance requirements for this equipment are as follows:
Inspect electrical connections for tightness and controls for proper operating each heating and cooling season. Service as required.



WARNING: As with any mechanical equipment, personal injury can result from sharp metal edges, etc., therefore, care should be taken when removing and working on metal parts.

BLOWER

The blower should be inspected and cleaned annually, in conjunction with maintenance of the motor and bearings. It is important to keep the blower wheels clean in order to avoid imbalance and vibration.

MOTOR

Check motor connections to ensure that they are secure and made in accordance with the wiring diagram.

The blower motor should be cleaned annually.



WARNING: Units with ECM motors have line voltage power applied at all times. Make sure power is disconnected before servicing.

FILTER

The air filter should be cleaned or replaced every 30 days or more frequently if severe conditions exist. Always replace the filter with the same type as originally furnished.



CAUTION: Never operate unit without a filter or with filter access door removed. Damage to blower motor or coil can result. Failure to follow this CAUTION could result in personal injury or product and property damage.

IMPORTANT: Factory authorized filters must be used when locating the filter inside the unit. For those applications where access to an internal filter is impractical, a field-supplied filter must be installed in the return duct system

COIL

Any dust or other contaminants which accumulate on the heat transfer surfaces interferes with the air flow and impairs heat transfer. The coil must be kept clean by any of the following methods.

- Cleaning with low-pressure compressed air.
- Flushing or rinsing with water (a detergent is advisable for greasy surfaces)
- Inspect cooling coil before each cooling season. The coils must be kept clean.

MAINTENANCE

DRAIN PIPING

The drain should always be:

- Connected or piped to an acceptable disposal point sloped away from the unit at least 1/8-inch per foot.
- Checked before summer operation.
- Periodically checked during summer operation.

Inspect drain pan cleanliness annually and clean as required. Inspect the condensate drain prior to and periodically during the cooling season, for proper draining.

PREVENTATIVE MAINTENANCE

To achieve maximum performance and service life of each piece of equipment, a formal schedule of regular maintenance should be established and maintained.

MAINTENANCE UPDATES

Contact factory for current Maintenance Program information.



P.O. BOX 270969, Dallas, TX 75227

www.firstco.com or www.ae-air.com

The manufacturer works to continually improve its products. It reserves the right to change design and specifications without notice.

©2022 First Co., Applied Environmental Air