



FIRST CO.
P.O. BOX 270969 - DALLAS, TEXAS 75227
PH. (214) 388-5751 | FAX (214) 388-2255
WWW.FIRSTCO.COM

SHWX Direct Drive

HORIZONTAL 0-10V DC INPUT CONTROLLED

Chilled Water

Hot Water

800 thru 4,000 Nominal CFM

Direct Drive ECM Motor



Table of Contents

SECTIONS	PAGE
Standard Features /options	2-4
Nomenclature	5
Componet Static Resistance	6
Fan Performance	7-12
Physical Data	13-14
24 Cooling / Heating Performance	15
36 Cooling / Heating Performance	16
48 Cooling / Heating Performance	17
60 Cooling / Heating Performance	18
90 Cooling / Heating Performance	19
120 Cooling / Heating Performance	20
Hot Water Heating Correction Factors	21
Guide Specifications	22



SHWX Direct Drive - Horizontal

Unit is a completely factory assembled, single-piece air handler.

Unit includes a fan and coil section with factory installed chilled water, preheat or reheat hot water coil position, and a 2" filter section. Field mounted components include a mixing box or discharge plenum.

STANDARD FEATURES

CABINET - Fabricated of heavy gauge galvanized steel. Seismic resistant mounting brackets are standard on 2-5 ton models.

BLOWER - Resiliently mounted, heavy duty, double inlet, forward curved blade, centrifugal type. Direct Drive ECM 0-10V DC controls and wheel is dynamically balanced for smooth, quiet operation.

COILS - Fabricated of 3/8" or 1/2" OD seamless copper tubes mechanically expanded to highly efficient aluminum fins to maximize heat transfer. All coils have manual air vents. All models have positive slope drain pans.

INSULATION - The entire interior of the cabinet is insulated with one (1) inch insulation.

FILTER - One inch throw away filters are provided as standard in all **2 - 5 ton** units. One inch filter is provided and permanent filters are provided as standard in all **7-1/2 - 10 ton** units. Optional permanent, Merv 8, Merv 11 and Merv 13 Filters also available in 1". **Filters can be changed without tools.** Space available for 2".

FACTORY WIRED - All standard motors are factory installed and wired at voltage specified by customer.

MOTOR - Standard motor for 2 through 5 ton have constant air flow ECM motor. The 7.5 through 10 ton have a constant torque motor. Standard motors have internal overload protection. All Motors are UL certified.

STANDARD FEATURES (CONT)

MISCELLANEOUS -

- Slotted mounting rails for easy installation (**2 -5 ton SHWX** only). Rails are turned down 1/2" on each end for safer and easier installation.
- 3/4 inch NPT drain connections.
- All units come with factory mounted control box.
- Header connections on the right side as standard. Knockouts are provided for conversion to the left side. (Looking with air flow).
- Drain pans are coated for corrosion protection.

OPTIONS

1. **6 row cooling coil** instead of standard 4 row coil (factory installed only).
2. **Stainless steel** drain pan.
3. **Hot water coil** can be field or factory installed in either the reheat or pre-heat position (reheat is standard).

PART NUMBER	FOR UNIT MODEL	MANIFOLD CONNECTIONS
24HWK	24SHWX	7/8" OD
36HWK	36SHWX	
48HWK	48SHWX	
60HWK	60SHWX	
90HWK	90SHWX	1-1/8" OD
120HWK	120SHWX	1-3/8" OD

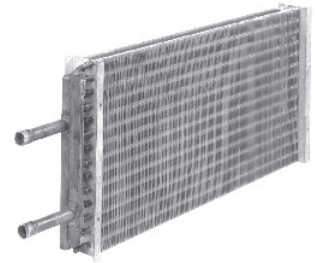

4. **Discharge plenum** with four way double - deflection grille (field installed) (for SHW units only)

PART NUMBER	FOR UNIT MODEL	DEPTH (1)
24DP	24SHWX	6"
36DP	36SHWX	
48DP	48SHWX	
60DP	60SHWX	
90DP	90SHWX	
120DP	120SHWX	

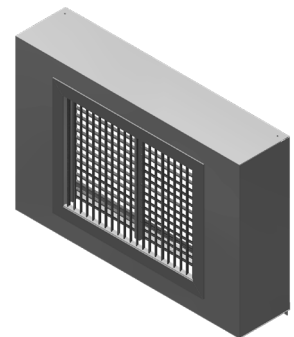

(1) Height and width are the same as the unit being attached to.

OPTIONS (CONT.)

Discharge Plenum

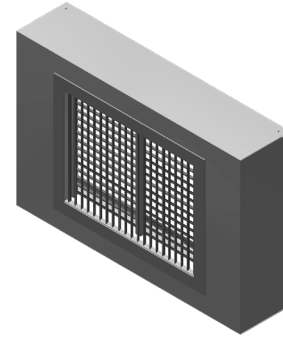

Side View

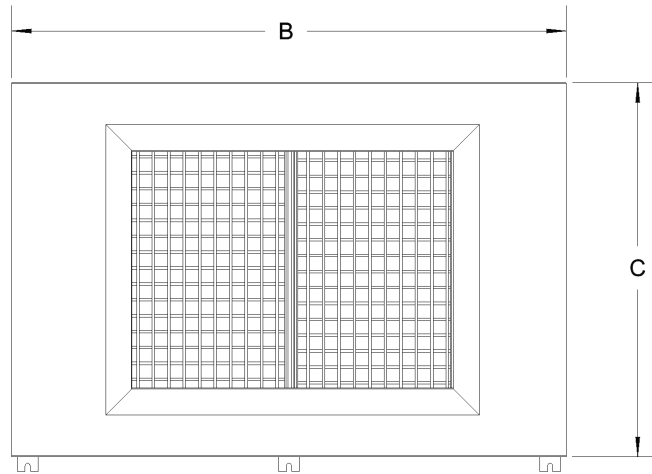

Front View

Part Number	For UNIT Model	A	B	C	GRILL SIZE	GRILL PART NUMBER #	SHIPPING WEIGHT
977-1*	24 SHWX	6.07	26.89	18.11	12" x 16"	G1612	20
977-2*	36 SHWX	6.07	36.39	18.11	12" x 24"	G2412	24
977-3*	48 SHWX	6.07	37.89	22.10	14" x 28"	G2814	27
977-4*	60 SHWX	6.07	44.89	22.10	14" x 34"	G3414	31
977-5*	90 SHWX	6.07	53.89	26.23	18" x 40"	G4018	35
977-6*	120 SHWX	6.07	56.89	31.23	22" x 46"	G4622	39
977-7*	180 SHWX	6.07	65.89	38.73	30" x 48"	G4830	43
977-8*	240 SHWX	6.07	65.89	51.23	40" x 48"	G4840	47

* = INSULATION OPTION CODE (I,F,G)

OPTIONS (CONT.)

Mixing Box

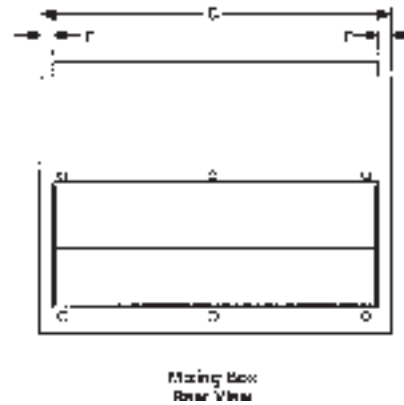
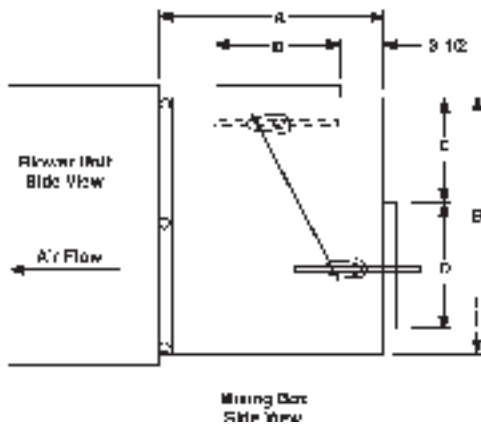
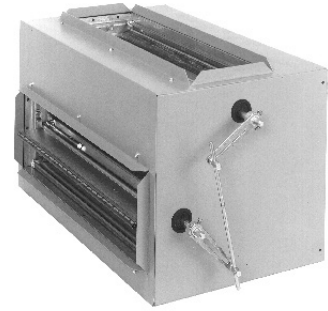

Dimensions:

MODEL	FOR UNIT MODEL	A	B	C	D	E	F	DAMPER SIZE (NOM)	SHIPPING WEIGHT
24MB	24SH, SV	16	16-3/8	18-1/8	8	6	1-1/16	2-16 x 8	40
36MB	36SH, SV	16	16-3/8	27-5/8	8	6	1-1/16	2-26 x 8	58
48MB	48SH, SV	18	20-3/8	29-1/8	10	8	1-1/16	2-27 x 10	65
60MB	60SH, SV	18	20-3/8	36-1/8	10	8	1-1/16	2-34 x 10	78
90MB	90SH, SV	18	25-3/8	45-1/8	10	8	1-1/16	2-42 x 10	110
120MB	120SH, SV	20	30-3/8	48-1/8	12	10	1-1/16	2-46 x 12	135

Features:

1. Cabinet fully insulated - 3/4 inch.
2. Galvanized cabinet on 24-120MB.
3. Crankarms and linkage rod for damper connection are furnished. Connections can be made on either side of mixing boxes. The balance of necessary linkage hardware, damper motor, and controls to be field supplied.
4. Dampers can be positioned for either rear/top or rear/bottom locations.
5. 1" duct flanges provided on damper openings.
6. Dampers have air seals on the edges for positive closing. 24-90MB have single horizontal damper blades. 120MB have double horizontal damper blades.
7. When used with water coil units, a "freezestat" must be installed to prevent coil damage caused by low ambient conditions.

NOMENCLATURE - Selection Procedure

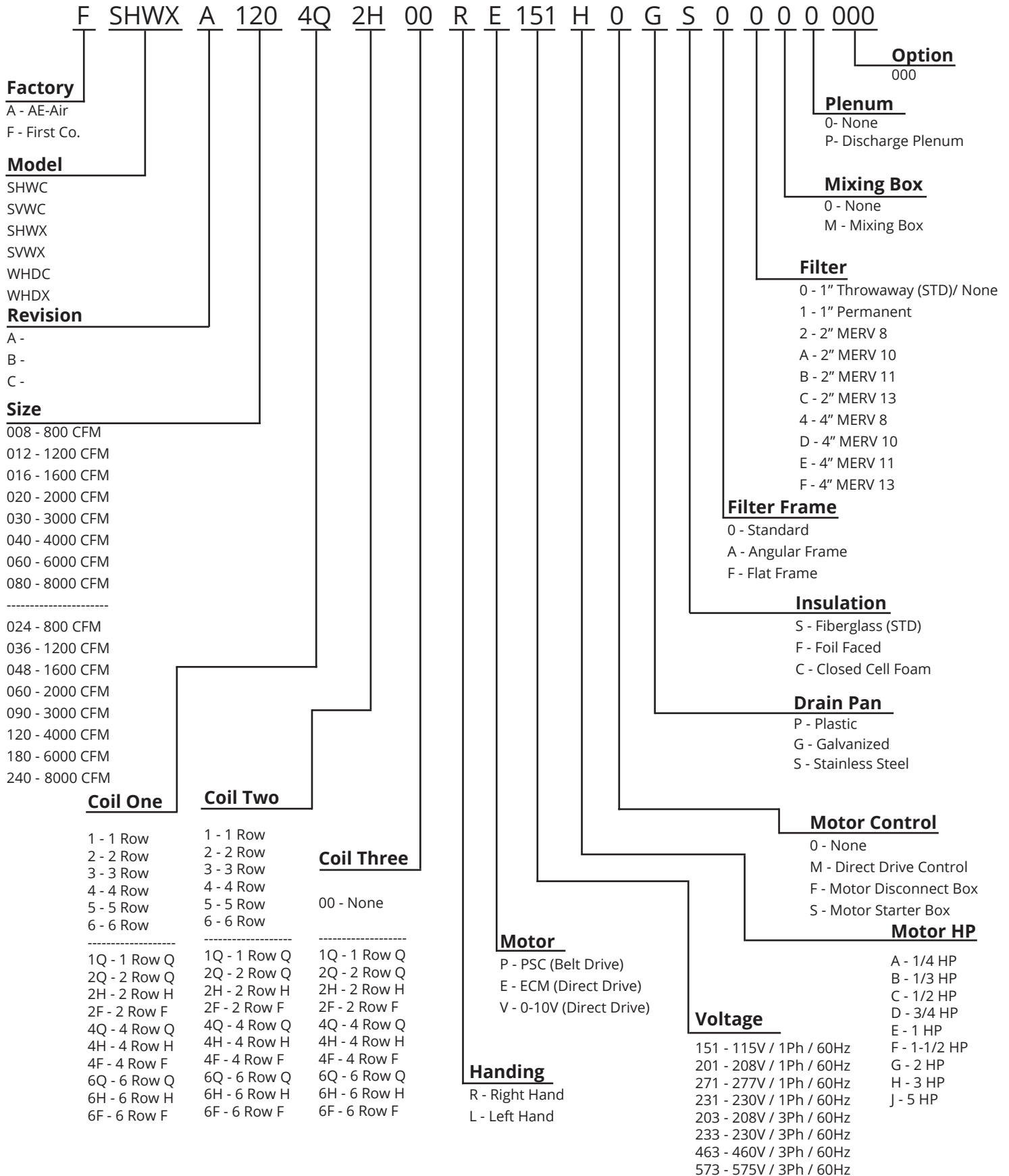

NOMENCLATURE - Selection Procedure

Drive Kit Nomenclature:

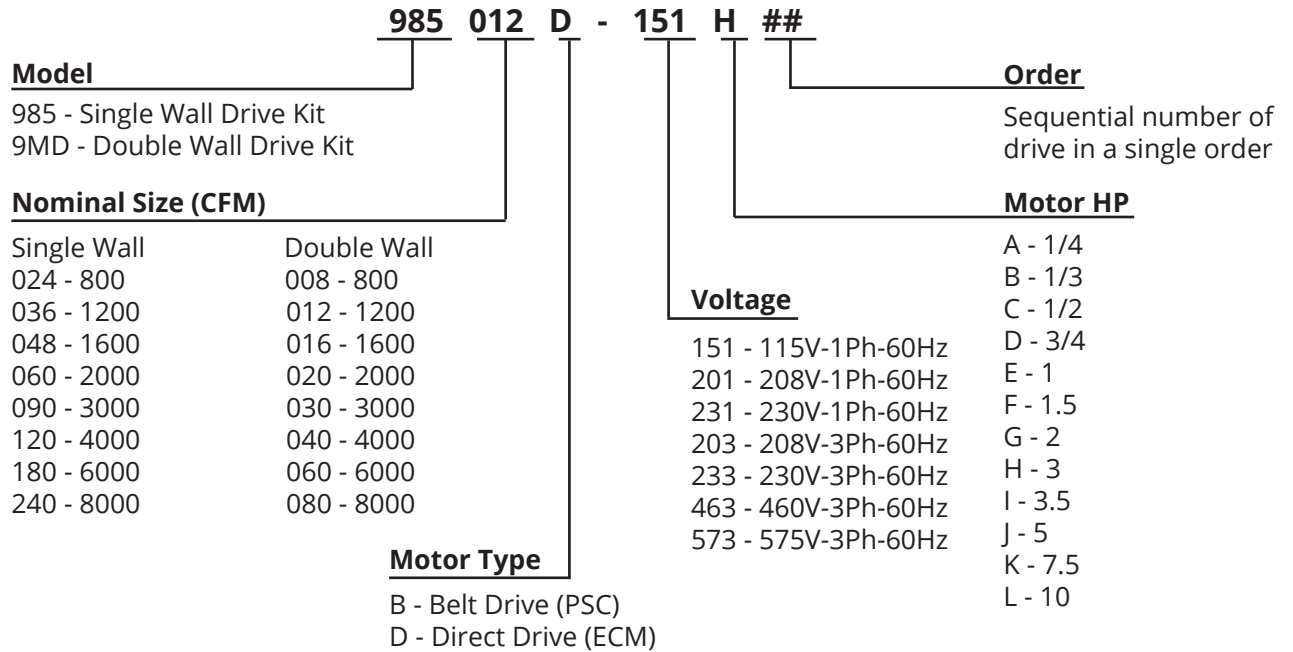

Required Order Information

1. Model number with rows and circuit
2. CFM and external static pressure
3. Motor HP
4. Actual voltage motor is to be wired to
5. Hot water coil installed in preheat or reheat position
6. Hand connections with air hitting you in back of head

COMPONENT STATIC RESISTANCE

MODEL	NOMINAL CFM	COMPONENT STATIC RESISTANCE (INCHES OF WATER)							
		CABINET	COOLING COIL*		HEATING COIL	STANDARD FILTER	MERV 8	MERV 11	MERV 13
			4 ROW	6 ROW	2 ROW				
24SHWX	600	0.09	0.14	0.22	0.07	0.04	0.18	0.24	0.32
	700	0.10	0.18	0.27	0.09	0.05			
	800	0.11	0.23	0.34	0.12	0.06			
	900	0.12	0.28	0.42	0.14	0.07			
	1000	0.13	0.33	0.50	0.18	0.08			
36SHWX	1000	0.09	0.17	0.25	0.08	0.04	0.18	0.24	0.32
	1100	0.10	0.19	0.28	0.10	0.05			
	1200	0.11	0.23	0.34	0.12	0.06			
	1300	0.12	0.26	0.39	0.13	0.07			
	1400	0.13	0.30	0.45	0.15	0.08			
48SHWX	1400	0.09	0.18	0.27	0.09	0.05	0.18	0.24	0.32
	1500	0.10	0.20	0.31	0.10	0.06			
	1600	0.11	0.23	0.34	0.11	0.06			
	1700	0.12	0.25	0.38	0.12	0.07			
	1800	0.13	0.28	0.42	0.13	0.08			
60SHWX	1800	0.10	0.20	0.28	0.09	0.05	0.18	0.24	0.32
	1900	0.11	0.21	0.31	0.10	0.06			
	2000	0.12	0.23	0.34	0.11	0.06			
	2100	0.13	0.25	0.37	0.12	0.07			
	2200	0.15	0.28	0.40	0.13	0.08			

MODEL	NOMINAL CFM	COMPONENT STATIC RESISTANCE (INCHES OF WATER)							
		CABINET	COOLING COIL*		HEATING COIL	STANDARD FILTER	MERV 8	MERV 11	MERV 13
			4 ROW	6 ROW	2 ROW				
90SHWX	2500	0.12	0.26	0.39	0.13	0.04	0.18	0.24	0.32
	2750	0.14	0.30	0.45	0.16	0.05			
	3000	0.16	0.34	0.51	0.18	0.06			
	3250	0.17	0.39	0.58	0.21	0.07			
	3500	0.19	0.44	0.65	0.24	0.08			
120SHWX	3400	0.14	0.29	0.43	0.14	0.05	0.18	0.24	0.32
	3700	0.15	0.33	0.48	0.16	0.06			
	4000	0.17	0.37	0.54	0.19	0.07			
	4300	0.19	0.41	0.61	0.21	0.08			
	4600	0.21	0.45	0.67	0.24	0.09			

* Wet Coil (Dry Coil P.D. = Wet P.D. x .70)

BLOWER DATA

Torque (%)	Static Pressure	CFM
100%	0.90	924
10.00	0.80	929
VDC	0.70	934
	0.60	939
	0.50	941
	0.30	956
80%	0.10	944
8.00	0.50	805
VDC	0.30	814
	0.10	802
	0.50	662
	0.30	659
60%	0.10	655
6.00	0.50	513
VDC	0.30	520
	0.10	507
	0.50	357
	0.30	375
40%	0.10	372
4.00	0.70	888
VDC	0.60	912
	0.50	935
	0.40	957
	0.30	978
	0.20	998
	0.10	1017
	0.00	1036
20%	0.13	537
2.00	0.10	544
VDC	0.00	582

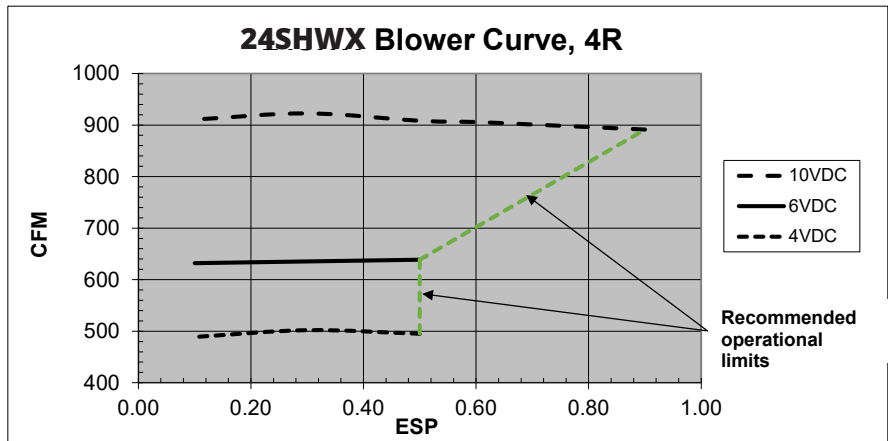
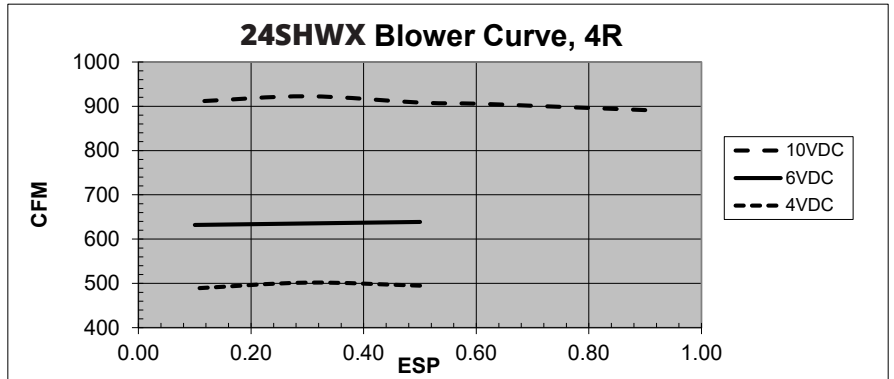

Note: Recommended range between 600-1000 CFM. Could do lower if measures to prevent coil freezing are taken

BLOWER DATA

Torque (%)	Static Pressure	CFM
100%	1.80	274
10.00	1.60	488
VDC	1.20	817
	0.80	1297
	0.40	1387
	0.00	1313
80%	1.75	263
8.00	1.60	441
VDC	1.20	757
	0.80	1226
	0.40	1234
	0.00	1155
60%	1.65	253
6.00	1.60	340
VDC	1.20	693
	0.80	1052
	0.40	1060
	0.00	965
40%	1.55	246
4.00	1.20	631
VDC	0.80	836
	0.40	864
	0.15	842
20%	1.53	252
2.00	1.20	628
VDC	0.80	834
	0.40	861
	0.15	842

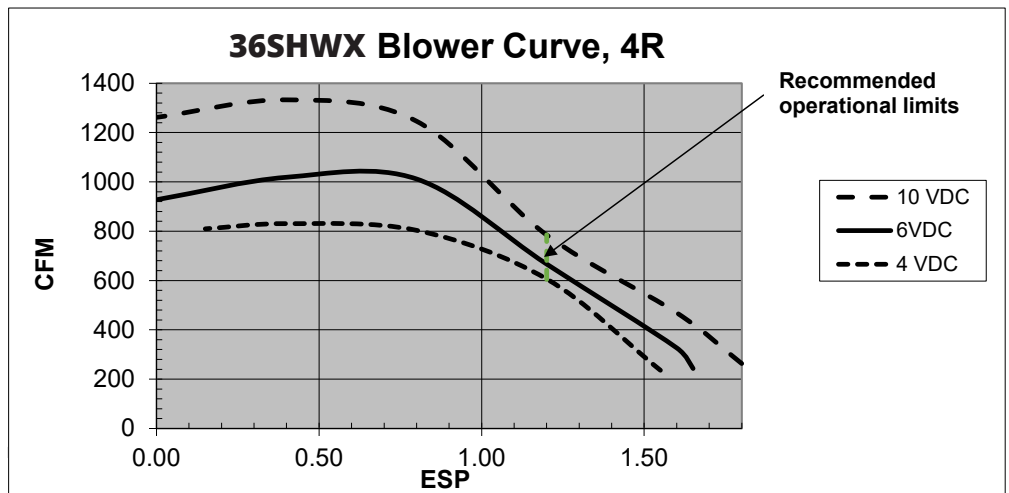
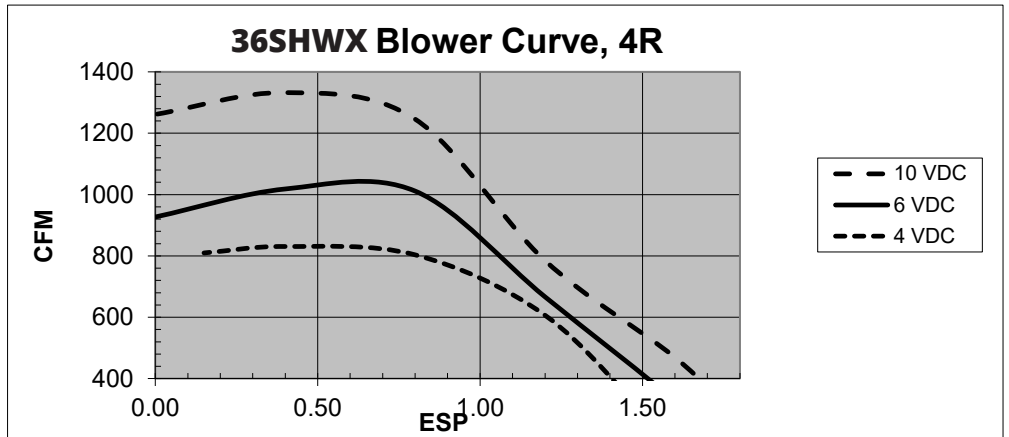

BLOWER DATA

Torque (%)	Static Pressure	CFM
100%	1.70	450
10.00	1.60	536
VDC	1.20	1360
	0.80	1346
	0.40	1708
	0.00	1689
80%	1.53	431
8.00	1.20	842
VDC	0.80	1266
	0.40	1431
	0.00	1418
60%	1.41	426
6.00	1.20	657
VDC	0.80	1061
	0.40	1103
	0.00	1108
40%	0.80	668
4.00	0.40	756
VDC	0.00	772
20%	0.75	265
2.00	0.40	345
VDC	0.00	430

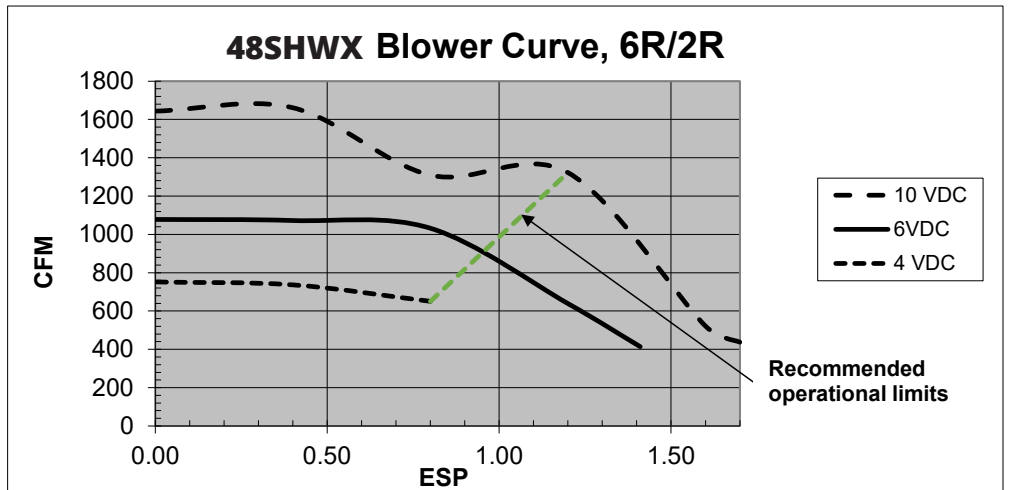
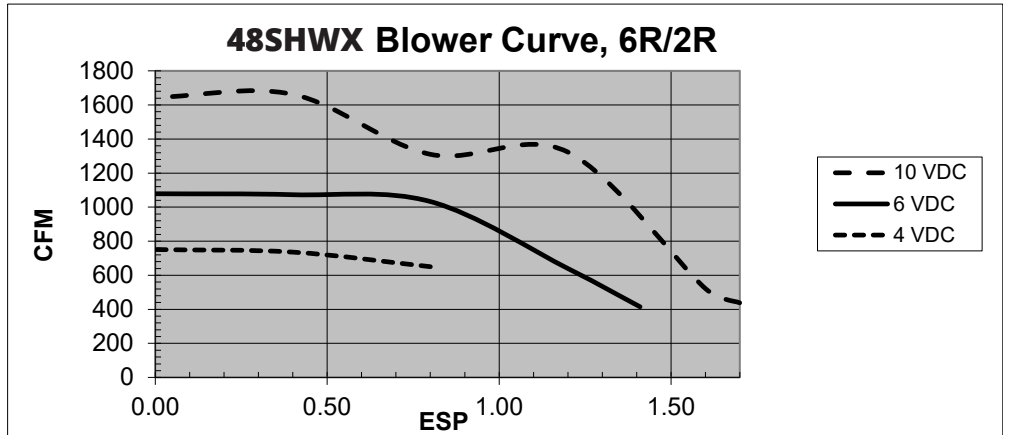

Note: Recommended range between 1400-1800 CFM. Could do lower if measures to prevent coil freezing are taken

BLOWER DATA

Torque (%)	Static Pressure	CFM
100%	2.00	1507
10.00	1.60	1958
VDC	1.20	2199
	0.80	2310
	0.40	2360
	0.00	2373
80%	2.00	1166
8.00	1.60	1750
VDC	1.20	1965
	0.80	1973
	0.40	1980
	0.00	1995
60%	2.00	645
6.00	1.60	1346
VDC	1.20	1552
	0.80	1579
	0.40	1591
	0.00	1583
40%	1.90	474
4.00	1.60	942
VDC	1.20	1111
	0.80	1155
	0.40	1173
	0.00	1155
20%	1.60	514
2.00	1.20	547
VDC	0.80	716
	0.40	776
	* 0.00	703

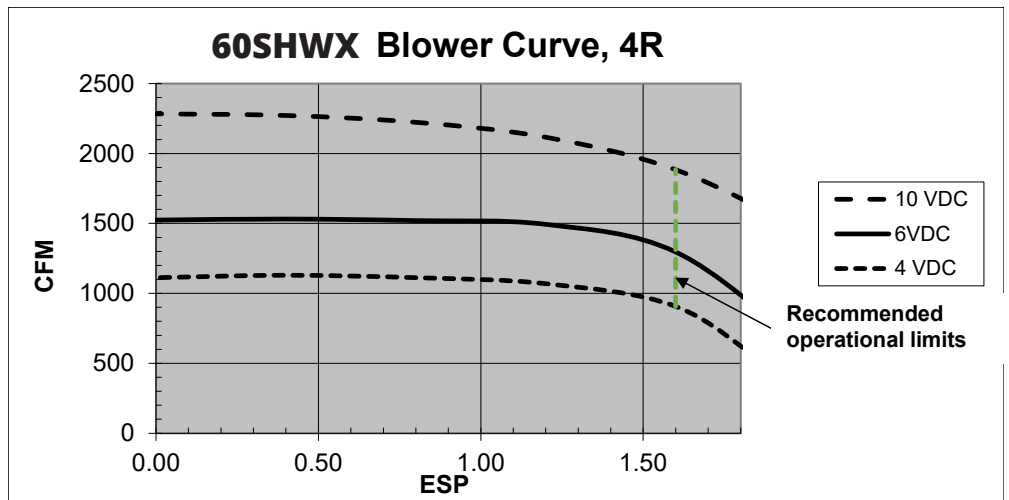
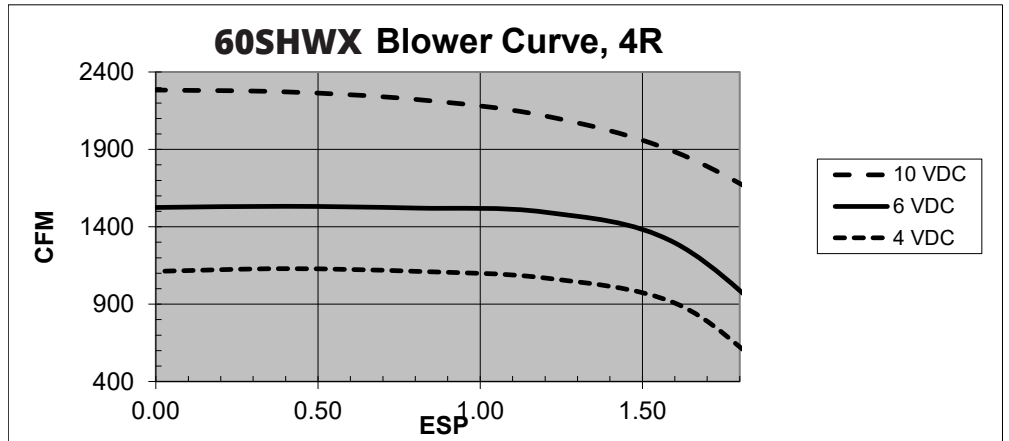

Note: Recommended range between 1800-2200 CFM. Could do lower if measures to prevent coil freezing are taken

BLOWER DATA

Torque (%)	Static Pressure	CFM
100%	2.20	4032
10.00	2.00	4131
VDC	1.60	4282
	1.20	4381
	0.80	4533
	0.40	4725
6.2VDC	2.00	3523
	1.60	3713
	1.20	3879
	0.80	4046
	0.40	4219
	0.00	4378
5.8VDC	2.00	3272
	1.60	3471
	1.20	3632
	0.80	3846
	0.40	4013
	0.00	4135
5.3VDC	2.00	3031
	1.60	3224
	1.20	3354
	0.80	3580
	0.40	3783
	0.00	3915
4.8VDC	2.00	2538
	1.60	2881
	1.20	2686
	0.80	2864
	0.40	2981
	0.00	3198

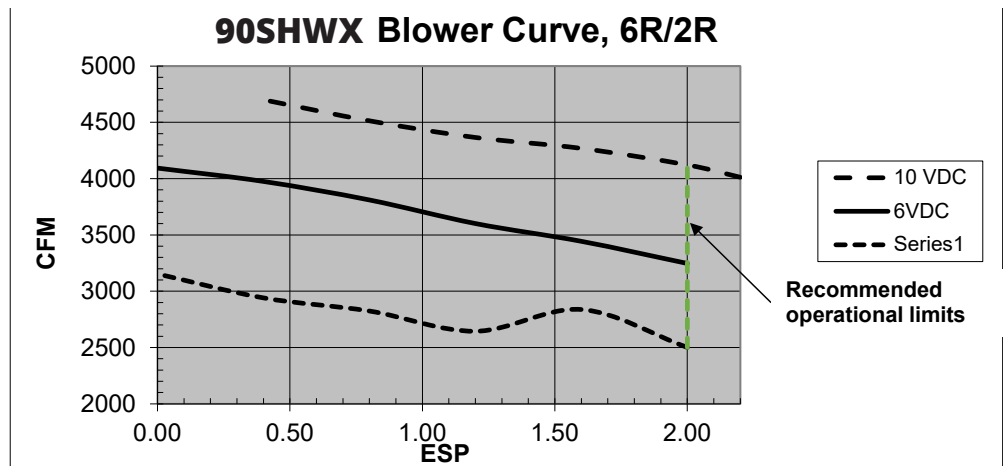
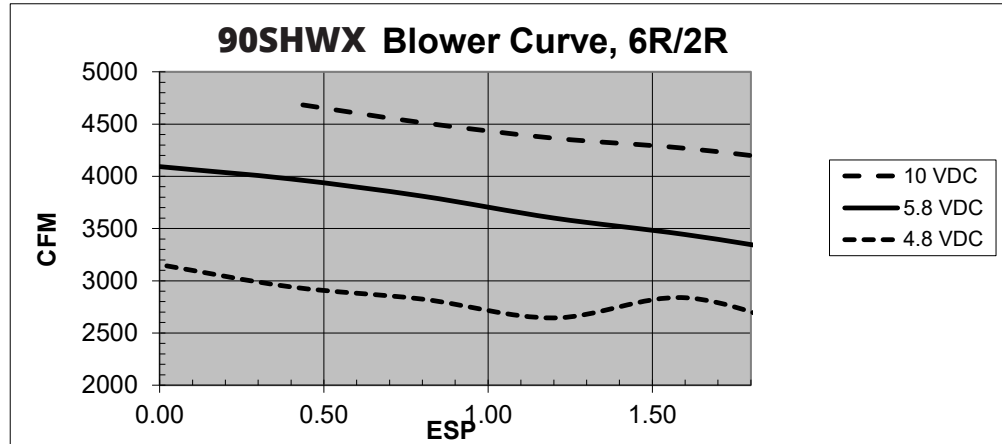

Note: Recommended range between 2500-3500 CFM. Could do lower if measures to prevent coil freezing are taken

BLOWER DATA

Torque (%)	Static Pressure	CFM
100%	2.00	6125
10.00	1.60	6280
VDC	1.20	6423
	0.80	6563
	0.40	6699
	0.00	6824
6.2VDC	2.00	4709
	1.60	4904
	1.20	5054
	0.80	5252
	0.40	5413
	0.00	5519
5.75VDC	2.00	4415
	1.60	4582
	1.20	4778
	0.80	4996
	0.40	5178
	0.00	5333
5.3VDC	2.20	3606
	2.00	3749
	1.60	4246
	1.20	4420
	0.80	4624
	0.40	4768
5.0VDC	2.00	3474
	1.60	3975
	1.20	4191
	0.80	4387
	0.40	4535
	0.00	4695

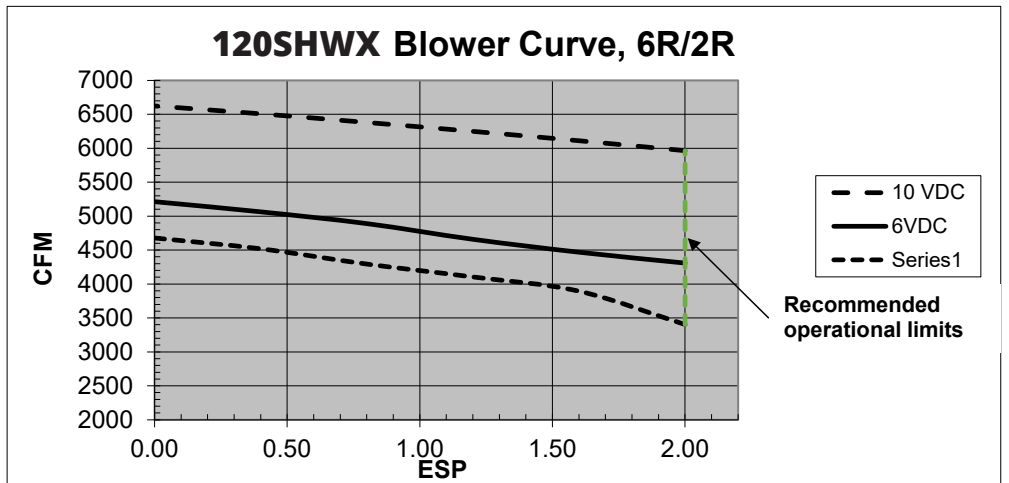
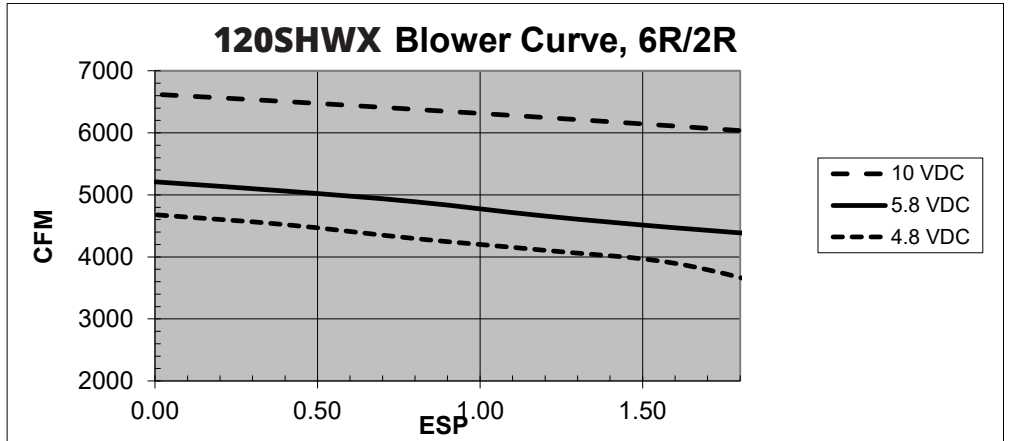

Note: Recommended range between 34500-4600 CFM. Could do lower if measures to prevent coil freezing are taken

PHYSICAL DATA

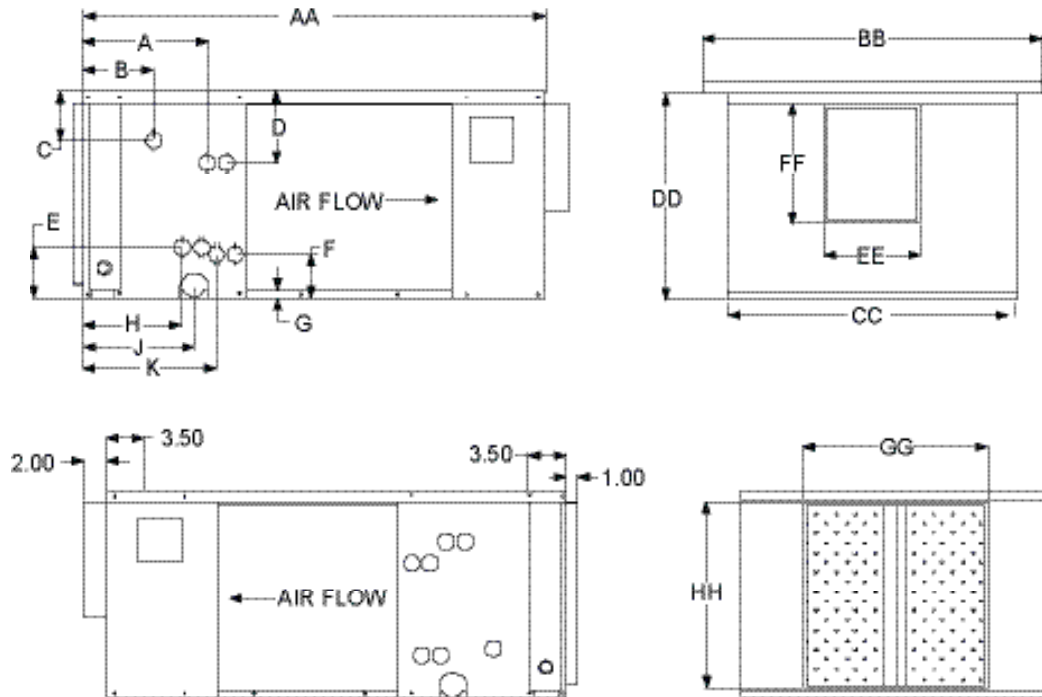

UNIT DIMENSIONS

MODEL	UNIT CABINET				BLOWER OUTLET		RETURN DUCT CONNECTION		STUBOUT LOCATION FOR WATER COILS									
	AA	BB	CC	DD	EE	FF	GG	HH	A	B	C	D	E	F	G	H	J	K
24SHWX4	37	32-1/2	27	18-7/8	8-3/4	10-7/8	18	16-1/4	11-1/4	6-5/16	4-1/2	6-1/2	4-1/2	3-15/16	1	8-15/16	10	12
36SHWX4	37	42	36-1/2	18-7/8	10-3/4	10-7/8	27-1/2	16-1/4	11-1/4	6-5/16	4-1/2	6-1/2	4-1/2	3-15/16	1	8-15/16	10	12
48SHWX4	39	43-1/2	38	22-7/8	12-1/4	10-7/8	29	20-1/4	11-1/4	6-5/16	3-3/4	5-3/4	4-1/2	3-15/16	1	8-15/16	10	12
60SHWX4	42	50-1/2	45	22-7/8	10-3/4	11-7/8	36	20-1/4	11-1/4	6-5/16	3-3/4	5-3/4	4-1/2	3-15/16	1	8-15/16	10	12

- Notes:**
- 1) All drain connections are 3/4" MPT and located on same side as coil connections.
 - 2) All units have knockouts on both sides for either (standard) or left side coil stub outs. (Looking with airflow) All coil connections must be on the same side of the unit.

GENERAL SPECIFICATIONS

MODEL	NOM. COOL TONS	FACE AREA SQ. FT.	TUBE SIZE	STD. MOTOR HP	VOLTS	PHASE	BLOWER SIZE	FILTER SIZE	4 ROW COIL		6 ROW COIL	
									MANIFOLD CONNECTION	SHIPPING WEIGHT	MANIFOLD CONNECTION	SHIPPING WEIGHT
24SHWX	2	2.05	3/8	1/3	115/230/277	1	9 X 6	16 X 25	7/8" O/D (SWT)	185	7/8" O/D (SWT)	205
36SHWX	3	3.05	3/8	1/2	115/230/277	1	9 X 8	16 X 16 (2)	7/8" O/D (SWT)	205	7/8" O/D (SWT)	225
48SHWX	4	4.0	3/8	3/4	115/230/277	1	9 X 9	16 X 20 (2)	7/8" O/D (SWT)	230	7/8" O/D (SWT)	265
60SHWX	5	5.0	3/8	1	115/230/277	1	10 X 8	20 X 20 (2)	1-1/8" O/D (SWT)	290	1-1/8" O/D (SWT)	310

- Notes:**
- 1) All technical specifications subject to change without notice.
 - 2) Additional charge for optional motors.
 - 3) When SHWX units are used with hot water coil the leaving air temperature must not exceed 150 degrees. At high altitude conditions, blower motor may cutout air lower LAT. Contact factory for information.
 - 4) Contact factory for electric heat information (supplied by others)

PHYSICAL DATA (CONT.)

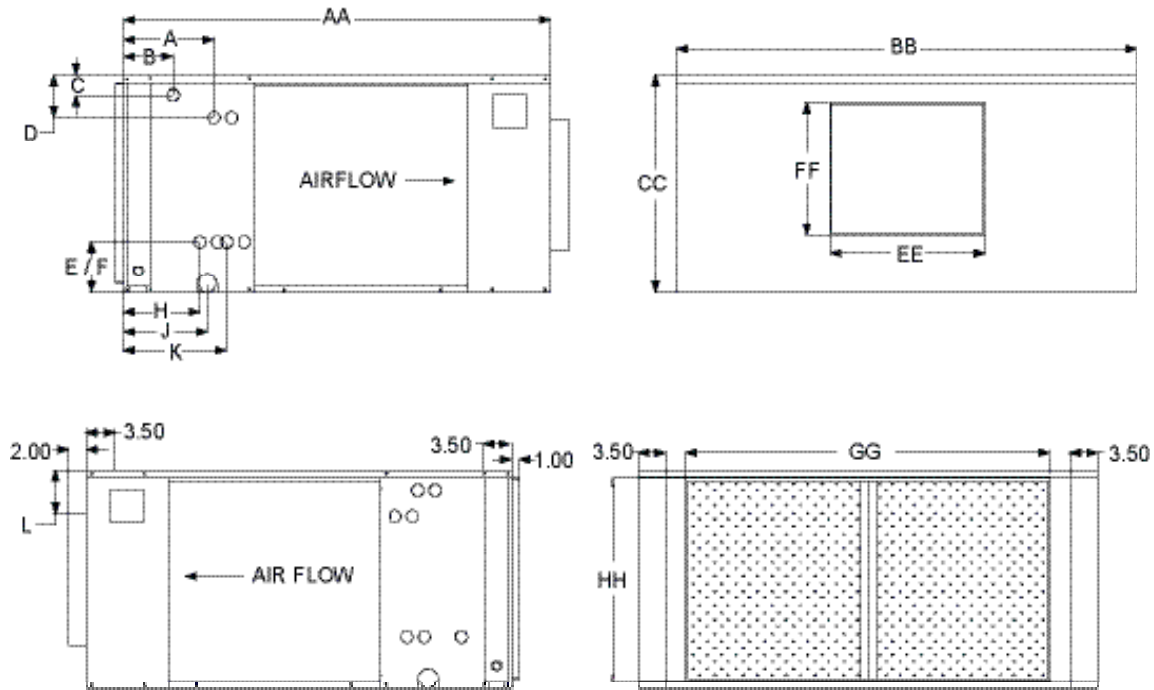

UNIT DIMENSIONS

MODEL	UNIT CABINET			BLOWER OUTLET		RETURN DUCT CONNECTION		STUBOUT LOCATION FOR WATER COILS										
	AA	BB	CC	EE	FF	GG	HH	A	B	C	D	E	F	G	H	J	K	L
90SHWX4	52-1/2	54	27	16-1/2	16-3/8	45	25-1/4	11-1/8	6-1/8	2-7/16	5-1/8	6-7/16	6-7/16	1	9-3/8	10-1/4	12-5/8	1
120SHWX4	52-1/2	57	32	19-1/8	16-3/8	48	30-1/4	11-1/8	6-1/8	2-7/16	5-1/8	6-7/16	6-7/16	1	9-3/8	10-1/4	12-5/8	6

- Notes:**
- 1) All drain connections are 3/4" MPT and located on same side as coil connections.
 - 2) All units have knockouts on both sides for either (standard) or left side coil stub outs. (Looking with airflow) All coil connections must be on the same side of the unit.

GENERAL SPECIFICATIONS

MODEL	NOM. COOL TONS	FACE AREA SQ. FT.	TUBE SIZE	STD. MOTOR HP	VOLTS	PHASE	BLOWER SIZE	FILTER SIZE	4 ROW COIL		6 ROW COIL	
									MANIFOLD CONNECTION	SHIPPING WEIGHT	MANIFOLD CONNECTION	SHIPPING WEIGHT
90SHWX	7-1/2	7.5	1/2	3.5	230/460/575	3	15 X 12	24 X 25 (2)	1-1/8"O/D(SWT)	450	1-1/8"O/D(SWT)	475
120SHWX	10	9.6	1/2	5	230/460/575	3	15 X 15	26 X 29 (2)	1-3/8"O/D(SWT)	490	1-3/8"O/D(SWT)	535

- Notes:**
- 1) All technical specifications subject to change without notice.
 - 2) Additional charge for optional motors.
 - 3) When SHWX units are used with hot water coil the leaving air temperature must not exceed 150 degrees.
At high altitude conditions, blower motor may cutout air lower LAT. Contact factory for information.
 - 4) Contact factory for electric heat information (supplied by others)

24SHWX CHILLED WATER COOLING CAPACITIES

ENT. WTR. °F	C.F.M.	24SHWX4 (4 ROW COIL)								G.P.M.	WTR. P.D. FT.	24SHWX6 (6 ROW COIL)							
		G.P.M.	WTR. P.D. FT.	80°F DB/67°F WB ENT. AIR			75°F DB/63°F WB ENT. AIR					80°F DB/67°F WB ENT. AIR			75°F DB/63°F WB ENT. AIR				
				TOTAL MBH	SENS. MBH	TEMP. RISE	TOTAL MBH	SENS. MBH	TEMP. RISE			TOTAL MBH	SENS. MBH	TEMP. RISE	TOTAL MBH	SENS. MBH	TEMP. RISE		
42	600	3.0	1.2	19.6	13.9	13.0	14.9	12.1	9.9	3.0	1.3	22.3	15.7	14.9	17.0	13.6	11.4		
	800			21.7	16.5	14.5	16.6	14.5	11.0			24.9	18.8	16.6	19.0	16.5	12.7		
	1000			23.2	18.7	15.5	17.7	16.6	11.8			26.7	21.6	17.8	20.4	19.1	13.6		
	42	600	6.0	4.4	24.8	15.9	8.3	18.9	13.7	6.3	5.0	3.3	26.9	17.5	10.8	20.6	15.0	8.2	
		800			29.0	19.2	9.7	22.2	16.7	7.4			31.3	21.2	12.5	24.0	18.4	9.6	
		1000			32.5	22.1	10.8	24.8	19.3	8.3			34.9	24.6	13.9	26.6	21.5	10.7	
		42	600	9.0	9.3	26.7	16.6	5.9	20.4	14.3	4.5	7.0	6.1	29.6	18.5	8.4	22.6	15.9	6.4
			800			31.8	20.3	7.1	24.3	17.6	5.4			35.2	22.8	10.0	26.9	19.6	7.7
			1000			36.3	23.6	8.1	27.7	20.4	6.2			39.8	26.5	11.4	30.4	23.0	8.7
45			600	3.0	1.2	17.9	13.3	12.0	13.7	11.6	9.1	3.0	1.3	20.5	14.9	13.7	15.6	13.1	10.4
			800			19.9	15.8	13.3	15.2	14.0	10.1			22.8	18.0	15.2	17.4	15.9	11.6
			1000			21.3	18.1	14.2	17.5	17.5	11.7			24.5	20.8	16.4	21.4	21.4	14.2
	45		600	6.0	4.4	22.7	15.1	7.6	17.4	13.1	5.8	5.0	3.3	24.7	16.6	9.9	18.9	14.3	7.5
			800			26.6	18.3	8.9	20.3	16.0	6.8			28.7	20.2	11.5	22.0	17.6	8.8
			1000			29.8	21.1	9.9	22.7	18.5	7.6			32.0	23.5	12.8	24.4	20.6	9.8
		45	600	9.0	9.3	24.5	15.8	5.4	18.7	13.6	4.2	7.0	6.1	27.1	17.5	7.7	20.7	15.1	5.9
			800			29.2	19.3	6.5	22.3	16.8	5.0			32.3	21.6	9.2	24.6	18.7	7.0
			1000			33.3	22.5	7.4	25.4	19.5	5.6			36.5	25.2	10.4	27.9	22.0	8.0
50			600	3.0	1.2	15.2	12.3	10.2	11.6	10.9	7.8	3.0	1.3	17.4	13.8	11.6	13.3	12.2	8.9
			800			16.9	14.8	11.3	12.8	12.8	8.6			19.4	16.8	12.9	15.6	15.6	10.4
			1000			18.1	17.0	12.1	14.6	14.6	9.7			20.9	19.5	13.9	17.8	17.8	11.9
	50		600	6.0	4.4	19.3	13.8	6.4	14.7	12.0	4.9	5.0	3.3	21.0	15.1	8.4	16.0	13.2	6.4
			800			22.6	16.8	7.5	17.3	14.8	5.8			24.4	18.6	9.8	18.7	16.3	7.5
			1000			25.3	19.5	8.4	19.3	17.2	6.4			27.2	21.7	10.9	20.8	19.2	8.3
		50	600	9.0	9.3	20.8	14.3	4.6	15.9	12.5	3.5	7.0	6.1	23.1	15.9	6.6	17.6	13.8	5.0
			800			24.8	17.6	5.5	19.0	15.5	4.2			27.4	19.7	7.8	20.9	17.2	6.0
			1000			28.3	20.6	6.3	21.6	18.1	4.8			31.1	23.2	8.9	23.7	20.3	6.8

HOT WATER HEATING CAPACITIES

24SHWX4 (4 ROW COIL)						
180°F ENTERING WATER TEMPERATURE						
CFM	GPM	WTR. P.D. FT.	TOTAL MBH	LVG. AIR °F	LVG. WTR °F	
600	3.0	1.2	47.5	143	148	
800			56.4	135	142	
1000			64.3	130	137	
600	6.0	4.4	52.0	150	163	
800			63.2	143	159	
1000			73.3	138	156	
600	9.0	9.3	53.6	153	168	
800			65.8	146	165	
1000			76.8	141	163	

24HWK (2 ROW COIL)					
180°F ENTERING WATER TEMPERATURE					
CFM	GPM	WTR. P.D. FT.	TOTAL MBH	LVG. AIR °F	LVG. WTR °F
600	3.0	0.9	33.3	121	158
800			38.4	115	154
1000			42.9	110	151
600	6.0	3.2	36.6	126	168
800			43.2	120	166
1000			49.0	115	164
600	9.0	6.7	37.9	128	172
800			45.3	122	170
1000			51.8	118	168

* 70 degree return air

* 70 degree return air

- Notes:**
- 1) See page 22 for hot water heating correction factors.
 - 2) Optional 6 row coils should not be used for heating.
 - 3) Optional 2 row hot water coils can be factory or field installed.
 - 4) When these units are used for hot water heating the leaving air temperature must not exceed 150 degrees. At high altitude conditions, blower motor may cutout at a lower LAT. Contact factory for information.

36SHWX CHILLED WATER COOLING CAPACITIES

ENT. WTR. °F	C.F.M.	36SHWX4 (4 ROW COIL)								36SHWX6 (6 ROW COIL)							
		G.P.M.	WTR. P.D. FT.	80°F DB/67°F WB ENT. AIR			75°F DB/63°F WB ENT. AIR			G.P.M.	WTR. P.D. FT.	80°F DB/67°F WB ENT. AIR			75°F DB/63°F WB ENT. AIR		
				TOTAL MBH	SENS. MBH	TEMP. RISE	TOTAL MBH	SENS. MBH	TEMP. RISE			TOTAL MBH	SENS. MBH	TEMP. RISE	TOTAL MBH	SENS. MBH	TEMP. RISE
42	1000	4.0	2.0	29.6	21.9	14.8	22.6	19.2	11.3	4.0	2.7	35.6	25.4	17.8	27.2	22.1	13.6
	1200			31.4	24.4	15.7	24.0	21.5	12.0			38.0	28.4	19.0	29.1	25.0	14.5
	1400			33.1	26.7	16.6	25.3	23.7	12.7			40.5	31.5	20.2	30.9	27.7	15.5
	1000	8.0	7.5	39.0	25.4	9.8	29.8	22.0	7.4	7.0	7.5	45.0	29.0	12.9	34.4	25.0	9.8
	1200			43.0	28.7	10.7	32.8	24.9	8.2			49.7	33.0	14.2	38.0	28.5	10.8
	1400			46.5	31.6	11.6	35.5	27.6	8.9			53.9	36.6	15.4	41.2	31.8	11.8
	600	12.0	16.3	42.6	26.8	7.1	32.5	23.1	5.4	10.0	14.5	49.5	31.0	9.9	37.8	26.5	7.6
	800			47.5	30.4	7.9	36.3	26.3	6.0			55.5	35.3	11.1	42.4	30.3	8.5
	1000			52.0	33.7	8.7	39.7	29.2	6.6			60.9	39.3	12.2	46.5	33.9	9.3
45	1000	4.0	2.0	27.2	21.0	13.6	21.7	18.5	10.4	4.0	2.7	32.6	24.2	16.3	24.9	21.3	12.5
	1200			28.8	23.4	14.4	22.0	20.7	11.0			34.9	27.3	17.4	26.7	24.0	13.3
	1400			30.4	25.8	15.2	25.0	25.0	12.5			37.1	30.3	18.6	28.4	26.8	14.2
	1000	8.0	7.5	35.8	24.2	8.9	27.3	21.0	6.8	7.0	7.5	41.3	27.6	11.8	31.5	23.9	9.0
	1200			39.4	27.3	9.9	30.1	23.9	7.5			45.6	31.3	13.0	34.8	27.2	10.0
	1400			42.6	30.2	10.7	32.6	26.4	8.1			49.5	34.9	14.1	37.8	30.4	10.8
	600	12.0	16.3	39.0	25.5	6.5	29.8	22.0	5.0	10.0	14.5	45.4	29.2	9.1	34.7	25.2	6.9
	800			43.6	28.9	7.3	33.3	25.1	5.5			50.9	33.4	10.2	38.9	28.9	7.8
	1000			47.7	32.1	7.9	36.4	27.9	6.1			55.9	37.3	11.2	42.7	32.3	8.5
50	1000	4.0	2.0	23.1	19.5	11.5	17.2	17.2	8.6	4.0	2.7	27.7	22.4	13.9	21.2	19.8	10.6
	1200			24.5	21.9	12.2	19.1	19.1	9.5			29.7	25.4	14.8	23.6	23.6	11.8
	1400			25.8	24.2	12.9	20.8	20.8	10.4			31.6	28.3	15.8	26.0	26.0	13.0
	1000	8.0	7.5	30.4	22.2	7.6	23.2	19.4	5.8	7.0	7.5	35.1	25.2	10.0	26.8	22.0	7.7
	1200			33.5	25.1	8.4	25.6	22.1	6.4			38.8	28.7	11.1	29.6	25.2	8.5
	1400			36.2	27.9	9.1	27.7	24.6	6.9			42.1	32.1	12.0	32.1	28.2	9.2
	600	12.0	16.3	33.2	23.2	5.5	25.3	20.3	4.2	10.0	14.5	38.6	26.5	7.7	29.5	23.1	5.9
	800			37.1	26.4	6.2	28.3	23.2	4.7			43.3	30.4	8.7	33.0	26.5	6.6
	1000			40.5	29.4	6.8	31.0	25.8	5.2			47.5	34.1	9.5	36.3	29.8	7.3

HOT WATER HEATING CAPACITIES

36SHWX4 (4 ROW COIL)					
180°F ENTERING WATER TEMPERATURE					
CFM	GPM	WTR. P.D. FT.	TOTAL MBH	LVG. AIR °F	LVG. WTR °F
1000	4.0	2.0	75.5	140	142
1200			83.9	135	138
1400			91.7	131	134
1000	8.0	7.5	83.9	148	159
1200			94.7	143	156
1400			105.1	140	154
1000	12.0	16.3	86.8	150	165
1200			98.9	146	163
1400			110.1	143	162

36HWK (2 ROW COIL)					
180°F ENTERING WATER TEMPERATURE					
CFM	GPM	WTR. P.D. FT.	TOTAL MBH	LVG. AIR °F	LVG. WTR °F
1000	4.0	1.6	53.3	119	153
1200			58.7	115	150
1400			65.4	112	148
1000	8.0	6.1	59.4	125	165
1200			66.2	121	164
1400			72.5	118	162
1000	12.0	13.1	61.5	127	170
1200			68.7	123	168
1400			75.4	120	167

* 70 degree return air

* 70 degree return air

- Notes:**
- 1) See page 22 for hot water heating correction factors.
 - 2) Optional 6 row coils should not be used for heating.
 - 3) Optional 2 row hot water coils can be factory or field installed.
 - 4) When these units are used for hot water heating the leaving air temperature must not exceed 150 degrees. At high altitude conditions, blower motor may cutout at a lower LAT. Contact factory for information.

48SHWX CHILLED WATER COOLING CAPACITIES

ENT. WTR. °F	C.F.M.	48SHWX4 (4 ROW COIL)								48SHWX6 (6 ROW COIL)							
		G.P.M.	WTR. P.D. FT.	80°F DB/67°F WB ENT. AIR			75°F DB/63°F WB ENT. AIR			G.P.M.	WTR. P.D. FT.	80°F DB/67°F WB ENT. AIR			75°F DB/63°F WB ENT. AIR		
				TOTAL MBH	SENS. MBH	TEMP. RISE	TOTAL MBH	SENS. MBH	TEMP. RISE			TOTAL MBH	SENS. MBH	TEMP. RISE	TOTAL MBH	SENS. MBH	TEMP. RISE
42	1400	6.0	3.9	42.9	31.0	14.3	32.8	27.2	10.9	5.0	2.3	45.6	33.8	18.2	34.8	29.6	13.9
	1600			45.1	33.6	15.0	34.5	29.6	11.5			47.5	36.7	19.0	36.3	32.3	14.5
	1800			46.5	35.9	15.5	35.5	31.6	11.8			48.7	39.3	19.5	37.2	34.7	14.9
	1400	10.0	10.3	52.6	34.7	10.5	40.2	30.1	8.0	8.0	5.5	57.0	38.2	14.2	43.5	33.1	10.9
	1600			56.4	37.9	11.3	43.1	32.9	8.6			60.7	41.7	15.2	46.3	36.2	11.6
	1800			59.7	40.7	11.9	45.6	35.5	9.1			63.7	44.9	15.9	48.7	39.2	12.2
	1400	13.0	17.0	56.3	36.1	8.7	43.0	31.2	6.6	11.0	10.1	63.6	40.9	11.6	48.6	35.2	8.8
	1600			60.8	39.6	9.4	46.5	34.3	7.1			68.6	44.8	12.5	52.4	38.7	9.5
	1800			65.0	42.8	10.0	49.6	37.1	7.6			73.1	48.5	13.3	55.8	42.0	10.1
45	1400	6.0	3.9	39.4	29.7	13.1	30.1	26.1	10.0	5.0	2.3	41.8	32.4	16.7	31.9	28.5	12.8
	1600			41.4	32.3	13.8	31.6	28.5	10.5			43.6	35.3	17.4	33.3	31.2	13.3
	1800			42.6	34.5	14.2	32.6	30.5	10.9			44.7	37.8	17.9	39.6	39.6	15.8
	1400	10.0	10.3	48.3	33.0	9.7	36.9	28.8	7.4	8.0	5.5	52.3	36.4	13.1	39.9	31.7	10.0
	1600			51.8	36.1	10.4	39.5	31.5	7.9			55.7	39.8	13.9	42.5	34.7	10.6
	1800			54.7	38.9	10.9	41.8	34.1	8.4			58.4	42.9	14.6	44.6	37.6	11.2
	1400	13.0	17.0	51.6	34.3	7.9	39.4	29.8	6.1	11.0	10.1	58.4	38.8	10.6	44.6	33.5	8.1
	1600			55.8	37.6	8.6	42.6	32.7	6.6			63.0	42.6	11.4	48.1	36.9	8.7
	1800			59.6	40.7	9.2	45.5	35.5	7.0			67.0	46.2	12.2	51.2	40.2	9.3
50	1400	6.0	3.9	33.5	27.6	11.2	24.2	24.2	8.1	5.0	2.3	35.5	30.2	14.2	28.4	28.4	11.4
	1600			35.2	30.1	11.7	26.1	26.1	8.7			37.1	32.9	14.6	30.7	30.7	12.3
	1800			36.2	32.2	12.1	28.0	28.0	9.3			38.0	35.5	15.2	33.0	33.0	13.2
	1400	10.0	10.3	41.0	30.3	8.2	31.3	26.6	6.3	8.0	5.5	44.4	33.4	11.1	33.9	29.3	8.5
	1600			44.0	33.2	8.8	33.6	29.3	6.7			47.3	36.6	11.8	36.1	32.3	9.0
	1800			46.5	35.9	9.3	35.5	31.7	7.1			49.7	39.7	12.4	37.9	35.0	9.5
	1400	13.0	17.0	43.9	31.4	6.8	33.5	27.5	5.2	11.0	10.1	49.6	35.4	9.0	37.9	30.9	6.9
	1600			47.4	34.5	7.3	36.2	30.3	5.6			53.5	39.0	11.8	40.9	34.1	7.4
	1800			50.7	37.4	7.8	38.7	32.9	6.0			57.0	42.4	10.4	43.5	37.2	7.9

HOT WATER HEATING CAPACITIES

48SHWX4 (4 ROW COIL)					
180°F ENTERING WATER TEMPERATURE					
CFM	GPM	WTR. P.D. FT.	TOTAL MBH	LVG. AJR °F	LVG. WTR °F
1400	6.0	3.9	106.3	140	145
1600			114.9	137	142
1800			123.3	133	139
1400	10.0	10.3	114.9	146	157
1600			125.3	143	155
1800			135.3	140	153
1400	13.0	17.0	118.0	148	162
1600			129.4	145	160
1800			140.0	142	158

48HWK (2 ROW COIL)					
180°F ENTERING WATER TEMPERATURE					
CFM	GPM	WTR. P.D. FT.	TOTAL MBH	LVG. AJR °F	LVG. WTR °F
1400	5.0	2.0	72.8	118	151
1600			78.0	115	149
1800			82.7	113	147
1400	8.0	4.8	79.2	122	160
1600			85.4	119	159
1800			91.4	117	157
1400	12.0	10.4	83.3	125	166
1600			90.2	122	165
1800			97.0	120	164

* 70 degree return air

* 70 degree return air

- Notes:**
- 1) See page 22 for hot water heating correction factors.
 - 2) Optional 6 row coils should not be used for heating.
 - 3) Optional 2 row hot water coils can be factory or field installed.
 - 4) When these units are used for hot water heating the leaving air temperature must not exceed 150 degrees. At high altitude conditions, blower motor may cutout at a lower LAT. Contact factory for information.

60SHWX CHILLED WATER COOLING CAPACITIES

ENT. WTR. °F	C.F.M.	60SHWX4 (4 ROW COIL)								60SHWX6 (6 ROW COIL)							
		G.P.M.	WTR. P.D. FT.	80°F DB/67°F WB ENT. AIR			75°F DB/63°F WB ENT. AIR			G.P.M.	WTR. P.D. FT.	80°F DB/67°F WB ENT. AIR			75°F DB/63°F WB ENT. AIR		
				TOTAL MBH	SENS. MBH	TEMP. RISE	TOTAL MBH	SENS. MBH	TEMP. RISE			TOTAL MBH	SENS. MBH	TEMP. RISE	TOTAL MBH	SENS. MBH	TEMP. RISE
42	1800	6.0	1.8	48.7	37.4	16.2	37.2	33.0	12.4	6.0	1.6	57.5	43.0	19.2	43.9	37.7	14.6
	2000			49.0	39.3	16.3	37.4	34.8	12.5			57.8	45.3	19.3	44.2	39.9	14.7
	2200			49.6	41.3	16.5	43.1	43.1	14.4			58.8	47.8	19.6	44.9	42.3	15.0
	1800	11.0	5.7	63.6	43.0	11.6	48.6	37.4	8.8	9.0	3.4	69.6	47.6	15.5	53.2	41.4	11.8
	2000			66.7	45.9	12.1	50.9	40.0	9.3			72.1	50.7	16.0	55.1	44.2	12.2
	2200			69.4	48.5	12.6	53.0	42.4	9.6			74.6	53.7	16.6	57.0	46.9	12.7
	1800	16.0	11.6	70.6	45.7	8.8	53.9	39.5	6.7	12.0	5.9	77.3	50.7	12.9	59.1	43.8	9.8
	2000			75.3	49.1	9.4	57.5	42.6	7.2			81.5	54.3	13.6	62.3	47.0	10.4
	2200			79.4	52.3	9.9	60.6	45.4	7.6			85.4	57.8	14.2	65.2	50.2	10.9
45	1800	6.0	1.8	44.7	35.9	14.9	34.1	31.8	11.4	6.0	1.6	52.7	41.2	17.6	40.3	36.3	13.4
	2000			45.0	37.9	15.0	37.1	37.8	12.4			53.1	43.6	17.7	40.5	38.5	13.5
	2200			45.5	39.9	15.2	39.2	39.2	13.1			53.9	46.0	18.0	48.3	48.3	16.1
	1800	11.0	5.7	58.4	41.0	10.6	44.6	35.8	8.1	9.0	3.4	63.8	45.4	14.2	48.8	39.6	10.8
	2000			61.2	43.8	11.1	46.7	38.4	8.5			66.2	48.4	14.7	50.5	42.4	11.2
	2200			63.7	46.4	11.6	48.6	40.7	8.8			68.5	51.4	15.2	52.3	45.1	11.6
	1800	16.0	11.6	64.8	43.4	8.1	49.5	37.7	6.2	12.0	5.9	71.0	48.2	11.8	54.2	41.8	9.0
	2000			69.1	46.7	8.6	52.7	40.7	6.6			74.8	51.7	12.5	57.1	45.0	9.5
	2200			72.9	49.8	9.1	55.6	43.5	7.0			78.3	55.1	13.1	59.8	48.0	10.0
50	1800	6.0	1.8	38.0	33.6	12.7	29.1	29.1	9.7	6.0	1.6	44.8	38.3	14.9	35.5	35.5	11.8
	2000			38.2	35.5	12.7	31.0	31.0	10.3			45.1	40.7	15.0	38.0	38.0	12.7
	2200			39.2	39.2	13.1	32.7	32.7	10.9			45.8	43.2	15.3	40.2	40.2	13.4
	1800	11.0	5.7	49.6	37.7	9.0	37.9	33.2	6.9	9.0	3.4	54.3	41.8	12.1	41.4	36.8	9.2
	2000			52.0	40.4	9.5	39.7	35.7	7.2			56.2	44.7	12.5	43.0	39.5	9.5
	2200			54.1	42.9	9.8	41.3	38.0	7.5			58.2	47.6	12.9	44.5	42.1	9.9
	1800	16.0	11.6	55.1	39.7	6.9	42.1	34.8	5.3	12.0	5.9	60.3	44.1	10.1	46.1	38.6	7.7
	2000			58.7	42.9	7.3	44.8	37.6	5.6			63.6	47.4	10.6	48.6	41.6	8.1
	2200			61.9	45.8	7.7	47.3	40.2	5.9			66.6	50.7	11.1	50.9	44.5	8.5

HOT WATER HEATING CAPACITIES

60SHWX4 (4 ROW COIL)					
180°F ENTERING WATER TEMPERATURE					
CFM	GPM	WTR. P.D. FT.	TOTAL MBH	LVG. AIR °F	LVG. WTR °F
1800	6.0	1.8	128.0	136	137
2000			136.2	133	135
2200			143.8	131	132
1800	11.0	5.7	142.6	143	154
2000			152.9	141	152
2200			162.6	138	150
1800	16.0	11.6	149.6	147	161
2000			160.8	144	160
2200			171.4	142	159

60HWK (2 ROW COIL)					
180°F ENTERING WATER TEMPERATURE					
CFM	GPM	WTR. P.D. FT.	TOTAL MBH	LVG. AIR °F	LVG. WTR °F
1800	6.0	3.1	93.1	118	149
2000			98.2	116	147
2200			103.1	113	145
1800	9.0	6.6	100.4	122	158
2000			106.5	119	156
2200			112.6	117	155
1800	12.0	11.5	104.4	124	163
2000			111.0	121	162
2200			117.7	120	160

* 70 degree return air

* 70 degree return air

- Notes:**
- 1) See page 22 for hot water heating correction factors.
 - 2) Optional 6 row coils should not be used for heating.
 - 3) Optional 2 row hot water coils can be factory or field installed.
 - 4) When these units are used for hot water heating the leaving air temperature must not exceed 150 degrees. At high altitude conditions, blower motor may cutout at a lower LAT. Contact factory for information.

90SHWX CHILLED WATER COOLING CAPACITIES

ENT. WTR. °F	C.F.M.	90SHWX4 / 90SVWX4 (4 ROW COIL)								90SHWX6 / 90SVWX6 (6 ROW COIL)							
		G.P.M.	WTR. P.D. FT.	80°F DB/67°F WB ENT. AIR			75°F DB/63°F WB ENT. AIR			G.P.M.	WTR. P.D. FT.	80°F DB/67°F WB ENT. AIR			75°F DB/63°F WB ENT. AIR		
				TOTAL MBH	SENS. MBH	TEMP. RISE	TOTAL MBH	SENS. MBH	TEMP. RISE			TOTAL MBH	SENS. MBH	TEMP. RISE	TOTAL MBH	SENS. MBH	TEMP. RISE
42	2500	10.0	2.2	80.4	60.2	16.1	61.4	52.8	12.3	11	1.6	94.2	66.6	17.1	71.9	58.0	13.1
	3000			85.2	67.6	17.0	65.0	59.6	13.0			100.3	74.9	18.2	76.6	65.6	13.9
	3500			89.4	74.7	17.9	76.5	76.5	15.3			106.6	83.3	19.4	81.4	73.3	14.8
	2500	15.0	4.7	96.3	66.3	12.8	73.5	57.6	9.8	21	5.5	120.7	77.2	11.5	92.2	66.3	8.8
	3000			104.5	74.8	13.9	79.8	65.3	10.6			133.4	87.8	12.7	101.9	75.8	9.7
	3500			111.2	82.7	14.8	84.9	72.5	11.3			144.9	98.0	13.8	110.1	84.8	10.5
	2500	22.0	9.8	108.1	71.0	9.8	82.6	61.3	7.5	31	11.5	133.3	82.4	8.6	101.8	70.3	6.6
	3000			119.3	80.6	10.8	91.1	69.8	8.3			149.6	94.4	9.6	114.2	80.9	7.4
	3500			128.8	89.4	11.7	98.3	77.8	8.9			164.1	105.7	10.6	125.3	90.9	8.1
45	2500	10.0	2.2	73.8	57.8	14.8	56.3	50.9	11.3	11	1.6	86.4	63.6	15.7	66.0	55.7	12.0
	3000			78.1	65.0	15.6	63.4	63.4	12.7			92.0	71.8	16.7	70.3	63.2	12.8
	3500			82.0	72.0	16.4	69.6	69.6	13.9			97.8	80.0	17.8	74.7	70.7	13.6
	2500	15.0	4.7	88.3	63.3	11.8	67.5	55.2	9.0	21	5.5	110.8	73.2	10.6	84.6	63.1	8.1
	3000			95.8	71.6	12.8	73.2	62.8	9.8			122.4	83.4	11.7	93.5	72.3	8.9
	3500			102.0	79.3	13.6	77.9	69.8	10.4			132.9	93.3	12.7	101.5	81.2	9.7
	2500	22.0	9.8	99.2	67.5	9.0	75.8	58.5	6.9	31	11.5	122.3	77.8	7.9	93.4	66.7	6.0
	3000			109.4	76.7	9.9	83.6	66.8	7.6			137.2	89.4	8.9	104.8	76.9	6.8
	3500			118.1	85.3	10.7	90.2	74.6	8.2			150.6	100.2	9.7	115.0	86.6	7.4
50	2500	10.0	2.2	62.7	53.7	12.5	47.2	47.2	9.4	11	1.6	73.5	58.8	13.4	56.1	51.8	10.2
	3000			66.4	60.8	13.3	52.8	52.8	10.6			78.2	66.7	14.2	62.5	62.5	11.4
	3500			69.6	69.6	13.9	58.0	58.0	11.6			83.1	74.7	15.1	68.5	68.5	12.5
	2500	15.0	4.7	75.1	58.3	10.0	57.4	51.3	7.6	21	5.5	94.2	66.6	9.0	71.9	58.0	6.8
	3000			81.5	66.2	10.9	62.2	58.5	8.3			104.1	76.3	9.9	79.5	66.7	7.6
	3500			86.7	73.7	11.6	63.3	63.3	8.4			113.0	85.7	10.8	86.3	75.2	8.2
	2500	22.0	9.8	84.3	61.7	7.7	64.4	54.0	5.9	31	11.5	103.9	70.4	6.7	79.4	61.0	5.1
	3000			93.0	70.5	8.5	71.0	61.9	6.5			116.6	81.2	7.5	89.1	70.6	5.7
	3500			100.4	78.7	9.1	76.7	69.3	7.0			128.0	91.4	8.3	97.7	79.7	6.3

HOT WATER HEATING CAPACITIES

90SHWX4 (4 ROW COIL)						
180°F ENTERING WATER TEMPERATURE						
CFM	GPM	WTR. P.D. FT.	TOTAL MBH	LVG. AIR °F	LVG. WTR °F	
2500	10.0	2.2	207.8	147	138	
3000			232.4	142	133	
3500			255.2	137	129	
2500	15.0	4.7	222.4	152	150	
3000			251.1	148	146	
3500			278.5	144	143	
2500	22.0	9.8	232.8	156	159	
3000			265.1	152	156	
3500			295.7	148	153	

90HWK (2 ROW COIL)						
180°F ENTERING WATER TEMPERATURE						
CFM	GPM	WTR. P.D. FT.	TOTAL MBH	LVG. AIR °F	LVG. WTR °F	
2500	8.0	1.0	146.2	124	143	
3000			160.5	120	140	
3500			171.5	115	137	
2500	14.0	2.8	162.3	130	157	
3000			180.4	126	154	
3500			196.2	122	153	
2500	21.0	6.1	171.1	133	164	
3000			191.2	129	162	
3500			209.1	125	160	

* 70 degree return air

* 70 degree return air

- Notes:**
- 1) See page 22 for hot water heating correction factors.
 - 2) Optional 6 row coils should not be used for heating.
 - 3) Optional 2 row hot water coil can be factory installed in either the reheat (std.) or preheat positions.
 - 4) When these units are used with hot water coil the leaving air temperature must not exceed 150 degrees. At high altitude conditions, blower motor may cutout at a lower LAT. Contact factory for information.

120SHWX CHILLED WATER COOLING CAPACITIES

ENT. WTR. °F	C.F.M.	120SHWX4 (4 ROW COIL)									120SHWX6 (6 ROW COIL)								
		G.P.M.	WTR. P.D. FT.	80°F DB/67°F WB ENT. AIR			75°F DB/63°F WB ENT. AIR			G.P.M.	WTR. P.D. FT.	80°F DB/67°F WB ENT. AIR			75°F DB/63°F WB ENT. AIR				
				TOTAL MBH	SENS. MBH	TEMP. RISE	TOTAL MBH	SENS. MBH	TEMP. RISE			TOTAL MBH	SENS. MBH	TEMP. RISE	TOTAL MBH	SENS. MBH	TEMP. RISE		
42	3400	12.0	2.0	104.7	80.0	17.4	79.9	70.3	13.3	15	1.7	130.7	91.5	17.4	99.8	79.6	13.3		
	4000			107.3	87.7	17.9	82.0	77.5	13.7			136.7	100.9	18.2	104.4	88.3	13.9		
	4600			111.7	95.9	18.6	98.5	98.5	16.4			143.5	110.7	19.1	109.6	97.3	14.6		
	3400	21.0	5.8	132.7	90.7	12.6	101.3	78.7	9.7	25	4.7	158.3	102.5	12.7	120.9	88.2	9.7		
	4000			142.6	100.9	13.6	108.9	88.0	10.4			172.3	114.8	13.8	131.6	99.2	10.5		
	4600			151.4	110.5	14.4	115.7	96.7	11.0			184.8	126.5	14.8	141.2	109.8	11.3		
	3400	30.0	11.4	145.5	95.8	9.7	111.1	82.7	7.4	35	9.1	173.2	108.7	9.9	132.3	92.9	7.6		
	4000			159.4	107.4	10.6	121.8	93.1	8.1			192.0	122.8	11.0	146.6	105.4	8.4		
	4600			171.6	118.2	11.4	131.0	102.8	8.7			208.4	135.9	11.9	159.2	117.1	9.1		
45	3400	12.0	2.0	96.0	76.8	16.0	73.3	67.8	12.2	15	1.7	119.9	87.4	16.0	91.6	76.4	12.2		
	4000			98.5	84.5	16.4	82.5	82.5	13.8			125.4	96.7	16.7	95.8	85.0	12.8		
	4600			102.5	92.6	17.1	89.5	89.5	14.9			131.6	106.3	17.5	100.5	93.8	13.4		
	3400	21.0	5.8	121.7	86.5	11.6	93.0	75.4	8.9	25	4.7	145.2	97.3	11.6	110.9	84.1	8.9		
	4000			130.9	96.4	12.5	100.0	84.4	9.5			158.1	109.2	12.6	120.7	94.8	9.7		
	4600			138.9	105.8	13.2	106.1	93.0	10.1			169.6	120.6	13.6	129.5	105.1	10.4		
	3400	30.0	11.4	133.5	91.0	8.9	102.0	79.0	6.8	35	9.1	158.9	102.8	9.1	121.3	88.4	6.9		
	4000			146.3	102.3	9.8	111.7	89.1	7.4			176.1	116.3	10.1	134.5	100.4	7.7		
	4600			157.4	112.8	10.5	120.2	98.5	8.0			191.2	129.0	10.9	146.0	111.7	8.3		
50	3400	12.0	2.0	81.6	71.6	13.6	62.1	62.1	10.3	15	1.7	101.9	80.6	13.6	77.8	71.0	10.4		
	4000			83.7	79.2	13.9	68.8	68.8	11.5			106.6	89.8	14.2	83.6	83.6	11.1		
	4600			89.5	89.5	14.9	74.6	74.6	12.4			111.9	99.1	14.9	90.9	90.9	12.1		
	3400	21.0	5.8	103.5	79.6	9.9	79.0	70.0	7.5	25	4.7	123.4	88.7	9.9	94.3	77.4	7.5		
	4000			111.2	89.1	10.6	85.0	78.7	8.1			134.4	100.1	10.7	102.6	87.6	8.2		
	4600			118.1	98.2	11.2	84.3	84.3	8.0			144.1	110.9	11.5	110.1	97.5	8.8		
	3400	30.0	11.4	113.5	83.3	7.6	86.7	73.0	5.8	35	9.1	135.1	93.2	7.7	103.1	81.0	5.9		
	4000			124.3	94.0	8.3	95.0	82.5	6.3			149.7	105.9	8.6	114.4	92.3	6.5		
	4600			133.8	103.9	8.9	102.2	91.5	6.8			162.5	117.9	9.3	124.1	103.0	7.1		

HOT WATER HEATING CAPACITIES

120SHWX4 (4 ROW COIL)						
180°F ENTERING WATER TEMPERATURE						
CFM	GPM	WTR. P.D. FT.	TOTAL MBH	LVG. AIR °F	LVG. WTR °F	
3400	12.0	2.0	273.2	144	135	
4000			302.6	140	130	
4600			328.3	136	125	
3400	21.0	5.8	301.4	152	151	
4000			337.0	148	148	
4600			370.7	144	145	
3400	30.0	11.4	314.4	155	159	
4000			352.9	152	156	
4600			389.8	148	154	

120HWK (2 ROW COIL)						
180°F ENTERING WATER TEMPERATURE						
CFM	GPM	WTR. P.D. FT.	TOTAL MBH	LVG. AIR °F	LVG. WTR °F	
3400	11.0	1.0	198.5	124	144	
4000			215.8	120	140	
4600			229.4	116	138	
3400	18.0	2.8	217.8	129	156	
4000			239.8	125	153	
4600			257.8	122	151	
3400	25.0	5.3	227.8	132	162	
4000			251.9	128	160	
4600			272.0	125	158	

* 70 degree return air

* 70 degree return air

- Notes:**
- 1) See page 22 for hot water heating correction factors.
 - 2) Optional 6 row coils should not be used for heating.
 - 3) Optional 2 row hot water coil can be factory installed in either the reheat (std.) or preheat positions.
 - 4) When these units are used with hot water coil the leaving air temperature must not exceed 150 degrees. At high altitude conditions, blower motor may cutout at a lower LAT. Contact factory for information.

HOT WATER HEATING CORRECTION FACTORS

ENTERING AIR TEMP. (°F)	ENTERING WATER TEMPERATURE (°F)								
	100	110	120	130	140	150	160	170	180
50	0.455	0.545	0.636	0.727	0.818	0.909	1.000	1.091	1.182
55	0.409	0.500	0.591	0.682	0.773	0.864	0.955	1.045	1.136
60	0.363	0.455	0.545	0.636	0.727	0.818	0.909	1.000	1.091
65	0.318	0.409	0.500	0.591	0.682	0.773	0.864	0.955	1.045
70	0.272	0.363	0.455	0.545	0.636	0.727	0.818	0.909	1.000
75	0.227	0.318	0.409	0.500	0.591	0.682	0.773	0.864	0.955
80	0.182	0.272	0.363	0.455	0.545	0.636	0.727	0.818	0.909

Notes:

- 1) To determine heating capacity at other than 180 deg. E.W.T. and 70 deg. E.A.T. multiply the selected heating capacity at 180 deg. times the appropriate correction factor from above chart.
- 2) These correction factors may be used on all First Co. published 180 deg. heating capacities.
- 3) When **SHWX** units are used for hot water heating the leaving air temperature must not exceed 150 degrees. At high altitude conditions, blower motor may cutout at a lower LAT. Contact factory for information.

GUIDE SPECIFICATIONS

Furnish and install First Co. **SHWX/SVWX** Series Blower - Coil units as indicated on the plans.

CABINETS

Cabinets shall be manufactured of heavy gauge galvanized steel. The entire interior of the cabinet shall be insulated with one inch thick IAQ type insulation. Removable access panels shall be provided on both sides of the cabinet for maintenance and service. All cabinets shall have 2" supply and 1" return flanges.

INSULATION

The entire interior of the cabinet shall be insulated with one (1) inch insulation. This insulation must meet the requirements of ASTM C 1071, ASTM G 21, ASTM G 22, NFPA 90A, UL-181, and the cleaning practices of NAIMA.

Closed Cell, foil faced insulation is available as a option.

MOTOR / BLOWERS

Blowers shall be resiliently mounted, forward curved blade, and of centrifugal type. Each wheel shall be dynamically balanced for smooth, quiet operation. ECM blowers are direct driven and controlled by 0-10VDC. All motors to be field or factory installed and wired at voltage specified by customer.

COILS

All **SHWX/SVWX** series coils shall consist of aluminum fins mechanically bonded onto 3/8" or 1/2" OD seamless copper tubing. All coils shall be leak tested at 350 PSIG minimum air pressure. Manual air vents shall be standard on all coils. Drain pans shall be coated for corrosion protection.

FILTERS

One inch throw away filters are standard in 2-5 ton **SHWX/SVWX** units. 1" Merv 8, 11 and 13 are also available.

One inch permanent filters are provided as standard in 7-10 ton **SHWX/SVWX** units. Merv 8, 11 and 13 Filters are also available in 1". Filters shall be accessible without tools.

LISTING

All standard motors are UL Listed. All air handlers shall be rated in accordance with ARI Standard 430.